

3rd Floor

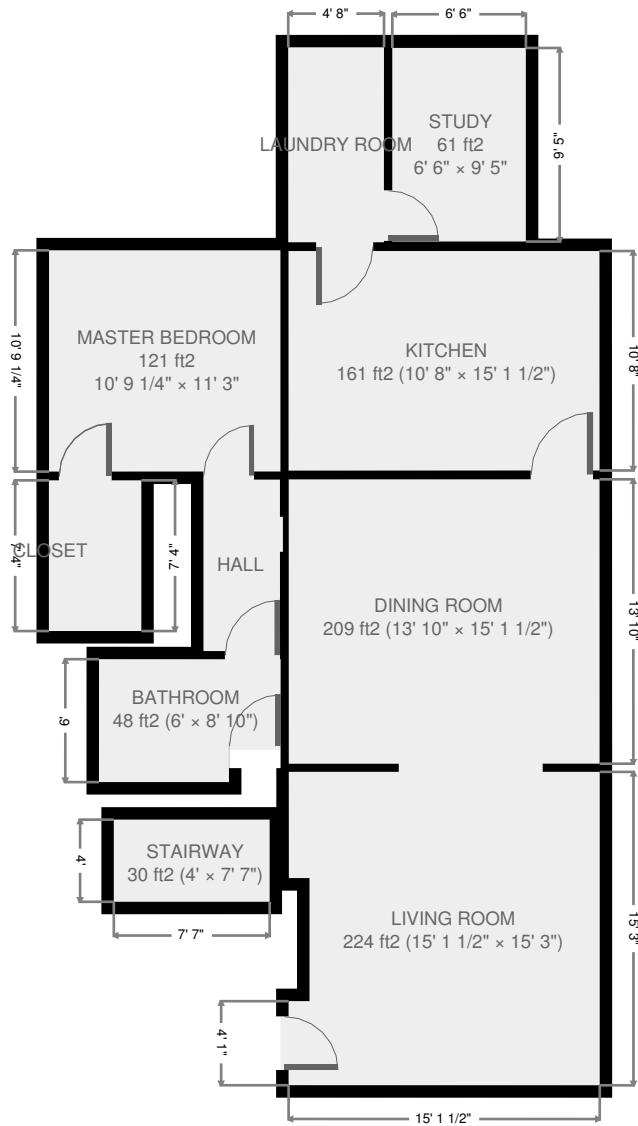

THIS FLOORPLAN IS PROVIDED WITHOUT WARRANTY OF ANY KIND. SENSOPIA DISCLAIMS ANY WARRANTY INCLUDING, WITHOUT LIMITATION, SATISFACTORY QUALITY OR ACCURACY OF DIMENSIONS.

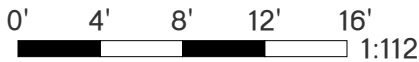

New Place

2014-12-21 10:08

964 ft²

1 Floor

8 Rooms

1 Bedroom

1 Bathroom

Kitchen

Width 10' 8"
 Length 15' 1 1/2"
 Area 161 ft²
 Perimeter 51' 7 1/4"
 Ceiling Height: 17'

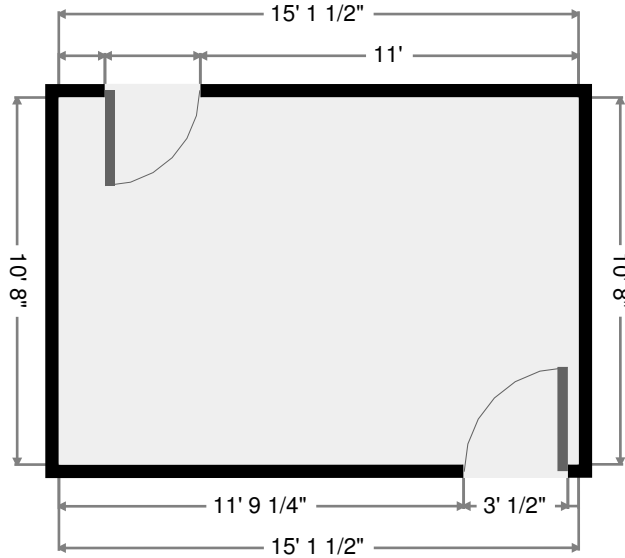
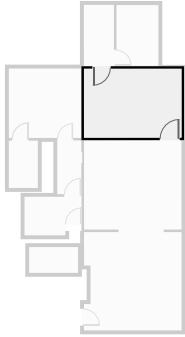

Dining Room

Width 13' 10"
 Length 15' 1 1/2"
 Area 209 ft²
 Perimeter 57' 10 3/4"
 Ceiling Height: 9' 1/4"

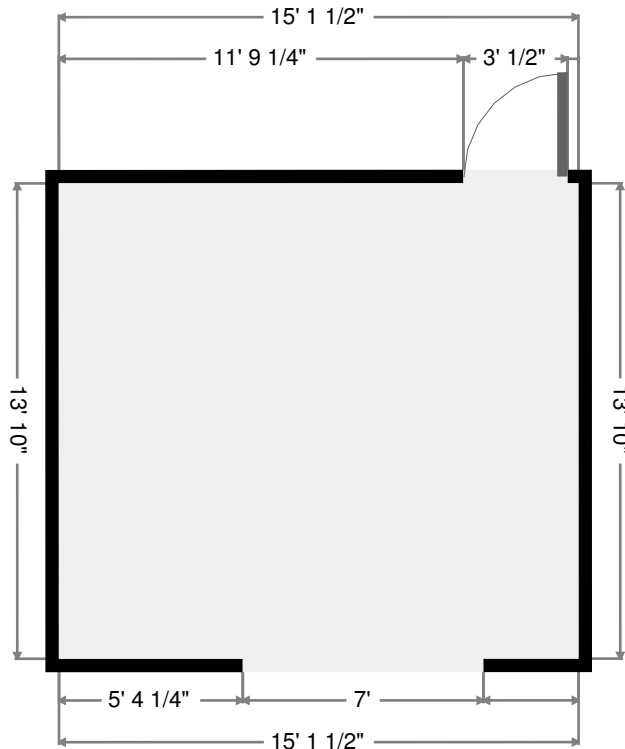
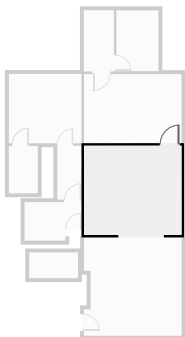

THIS FLOORPLAN IS PROVIDED WITHOUT WARRANTY OF ANY KIND. SENSOPIA DISCLAIMS ANY WARRANTY INCLUDING, WITHOUT LIMITATION, SATISFACTORY QUALITY OR ACCURACY OF DIMENSIONS.

2014-12-21 10:08

New Place

Living Room

Width 15' 1 1/2"
 Length 15' 3"
 Area 224 ft²
 Perimeter 62' 9"
 Ceiling Height: 8' 11"

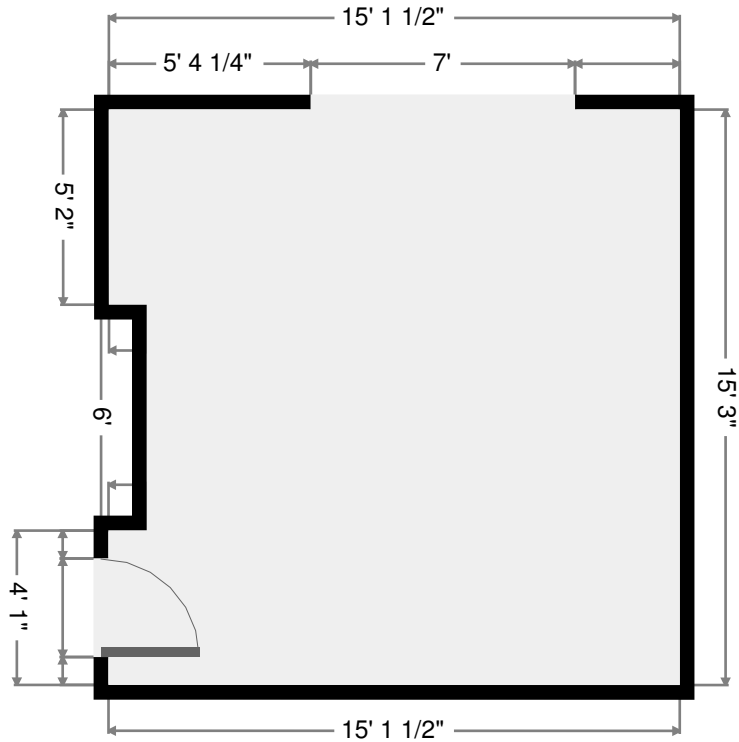
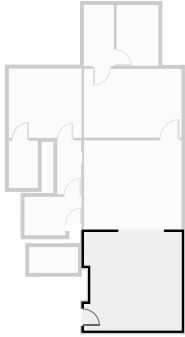

Bathroom

Width 6'
 Length 8' 10"
 Area 48 ft²
 Perimeter 29' 7 1/2"
 Ceiling Height: 9' 2 3/4"

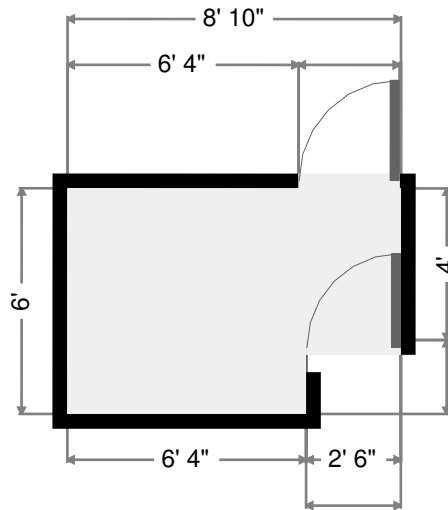
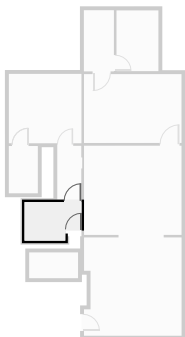

THIS FLOORPLAN IS PROVIDED WITHOUT WARRANTY OF ANY KIND. SENSOPIA DISCLAIMS ANY WARRANTY INCLUDING, WITHOUT LIMITATION, SATISFACTORY QUALITY OR ACCURACY OF DIMENSIONS.

2014-12-21 10:08

New Place

Master Bedroom

Width 10' 9 1/4"
 Length 11' 3"
 Area 121 ft²
 Perimeter 44' 1/4"
 Ceiling Height: 11' 9 1/2"

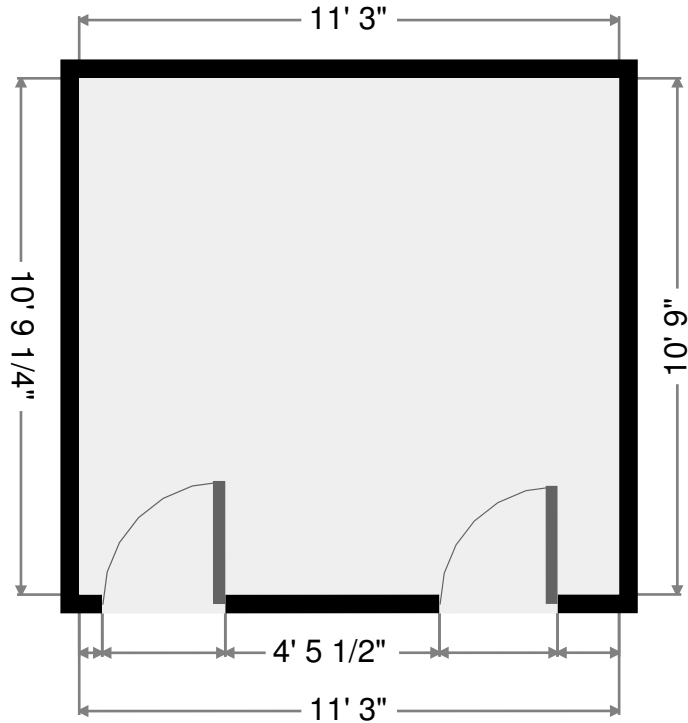
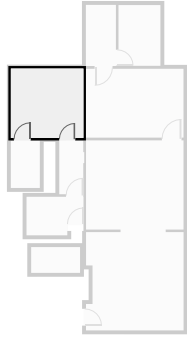

Closet

Width 4' 6"
 Length 7' 4"
 Area 33 ft²
 Perimeter 23' 7 3/4"
 Ceiling Height: 8' 10"

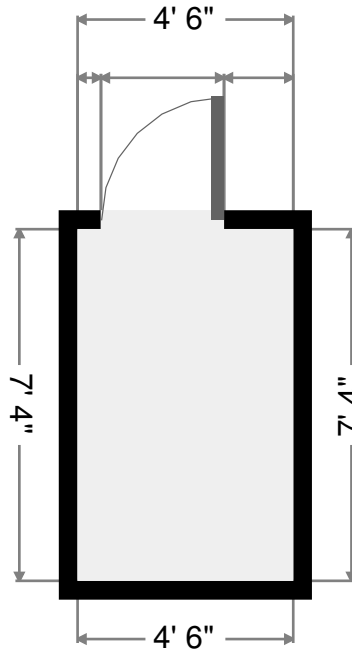
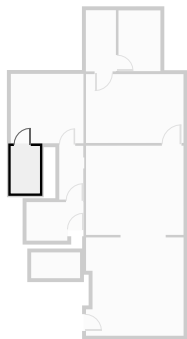

THIS FLOORPLAN IS PROVIDED WITHOUT WARRANTY OF ANY KIND. SENSOPIA DISCLAIMS ANY WARRANTY INCLUDING, WITHOUT LIMITATION, SATISFACTORY QUALITY OR ACCURACY OF DIMENSIONS.

2014-12-21 10:08

New Place

Stairway

Width 4'
Length 7' 7"
Area 30 ft²
Perimeter 23' 1 3/4"
Ceiling Height: 12' 10 1/4"

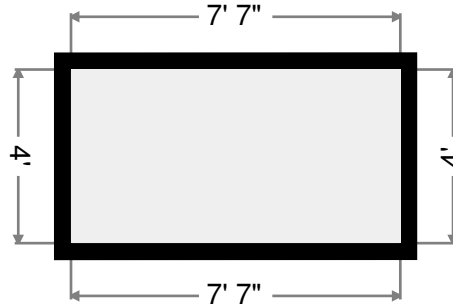
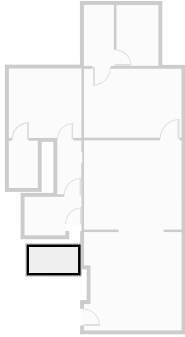

Hall

Width 3' 10 1/2"
Length 8' 4"
Area 31 ft²
Perimeter 24' 5"
Ceiling Height: 9' 2 1/2"

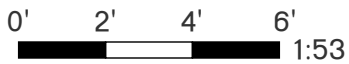
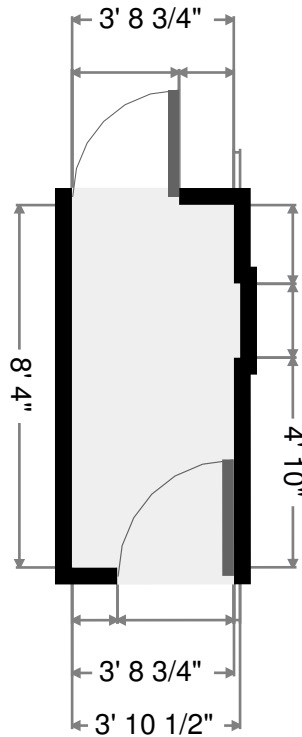
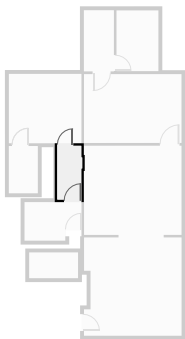

THIS FLOORPLAN IS PROVIDED WITHOUT WARRANTY OF ANY KIND. SENSOPIA DISCLAIMS ANY WARRANTY INCLUDING, WITHOUT LIMITATION, SATISFACTORY QUALITY OR ACCURACY OF DIMENSIONS.

2014-12-21 10:08

New Place

Study

Width 6' 6"
 Length 9' 5"
 Area 61 ft²
 Perimeter 31' 10"
 Ceiling Height: 9' 2"

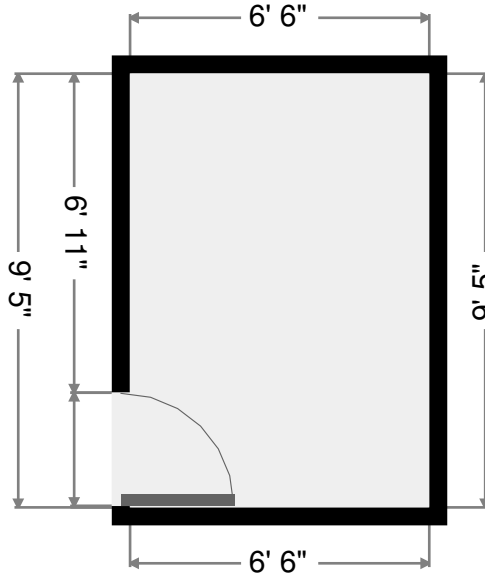
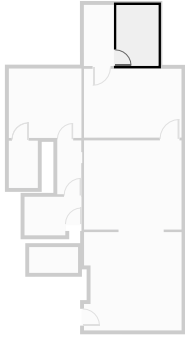

Laundry Room

Width 4' 8"
 Length 9' 5 3/4"
 Area 44 ft²
 Perimeter 28' 3 1/4"
 Ceiling Height: 10' 1/2"

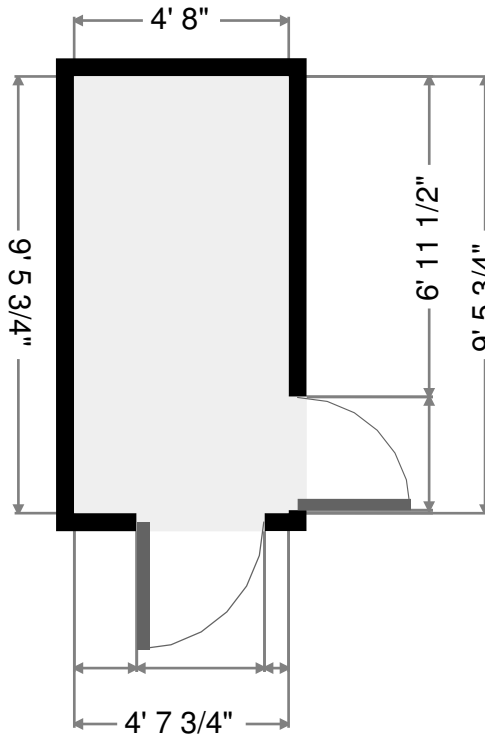
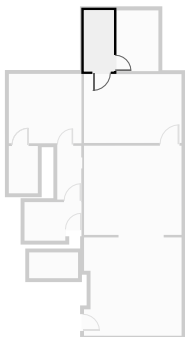

THIS FLOORPLAN IS PROVIDED WITHOUT WARRANTY OF ANY KIND. SENSOPIA DISCLAIMS ANY WARRANTY INCLUDING, WITHOUT LIMITATION, SATISFACTORY QUALITY OR ACCURACY OF DIMENSIONS.

2014-12-21 10:08

New Place