



Measuring Tools

- 6' Level • 4' Level • 2' Level • Tape Measure • Pencil
- Marking Tape • Protractor • Basco Measuring Sheet

Guidelines for Measuring

Ordering the correct size enclosure is the first step to a proper installation. The drawings on the following pages are designed to help you provide us with this information.

The final page can be used to hand draw any custom applications. Included below are helpful tips and recommendations for obtaining the needed measurements.

Please take a moment to review. We can never have too much information regarding your application.

"Proper Preparation Prevents Poor Performance",
 Author Unknown.

Custom Application Measuring

- A. Centerline dimension of the threshold: _____
- B. Height of the buttness (if applicable): _____
- C. Centerline dimensions of the return panel(s): _____
- D. Maximum height the application will accept: _____
- E. Notch width (if applicable): _____
- F. Degree of angle(s) on any return panel(s): _____
- G. Indicate what height unit you prefer: _____
 (Check current price list for standard heights.)

Note: Indicate on drawing where door and panel(s) are located and where showerhead is positioned. Also, please indicate any out of plumb/level conditions.

Checklist for Measuring

- ✓ Measuring must be done after finished wall material is in place.
- ✓ Measure each width or centerline (middle of threshold) as demonstrated by arrowed lines. Remember to allow for the body of the measuring tape.
- ✓ Measure maximum height available from top of tub deck or threshold to top of tile or fiberglass walls. This measurement will assist your distributor in selecting the most appropriate standard height from Basco's Distributor Price List. Custom heights are also available. Steam tight units are designed to fill the entire opening.
- ✓ Check all surfaces (including top of buttness if applicable) and walls for level. If any surface is out of level 3/8" or more, a tapered filler* is recommended. Please indicate on drawing where out of level conditions exist.
- ✓ Indicate showerhead position on drawing with an "X".

*Your distributor can provide part numbers and pricing for fillers from Basco's Parts Price List.

OVERHEAD VIEW

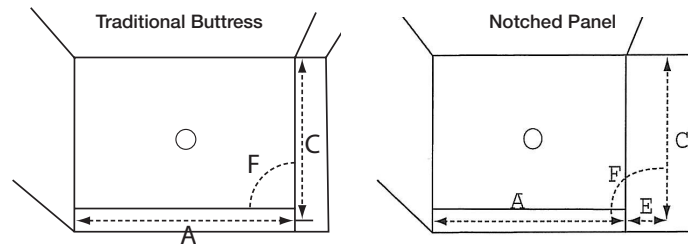

FRONT VIEW

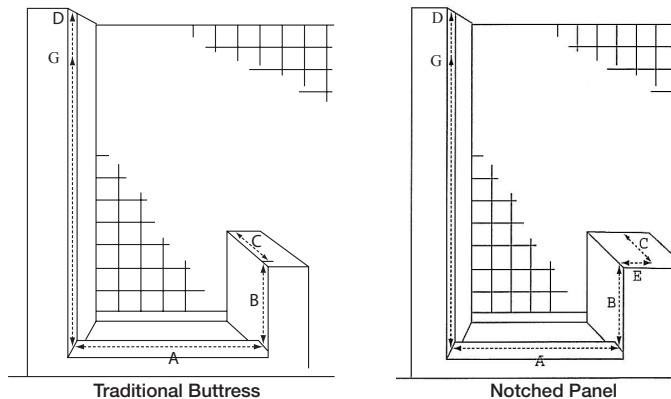

LEVEL & PLUMB

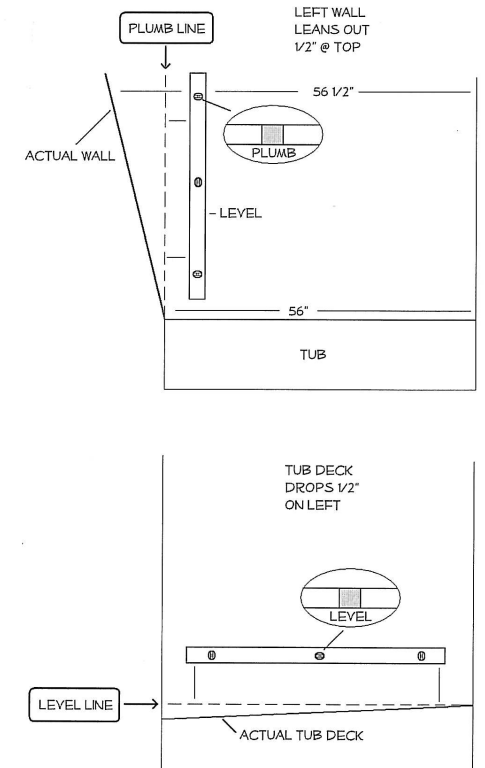

Measurements For Your



Neo-Angle or 90° Corner Shower Door

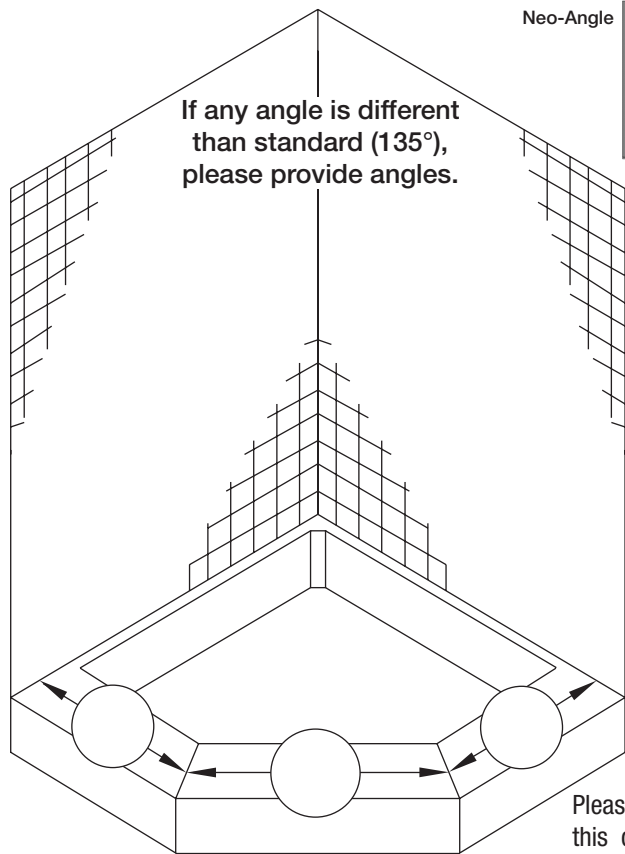

Neo-Angle

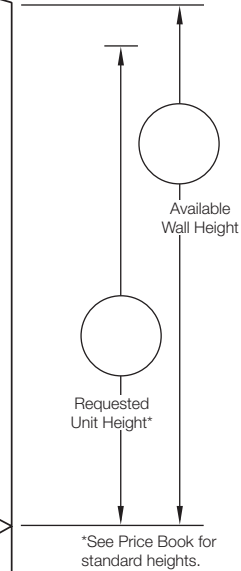
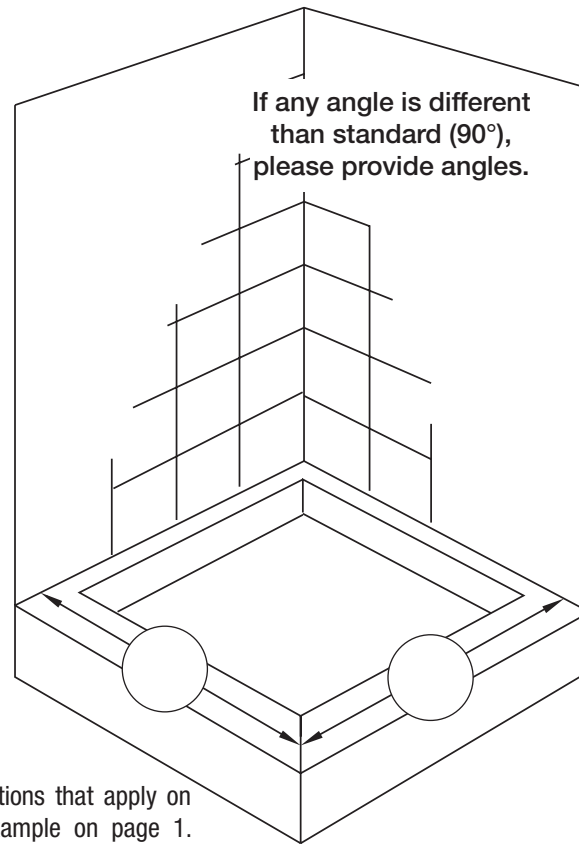
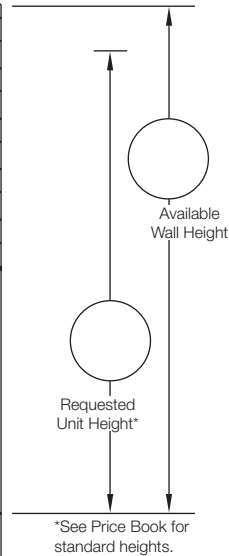

90° Corner Shower
36" x 48"

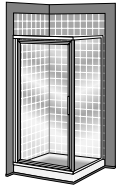

90° Corner Shower
48" x 48"

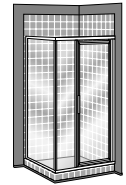

Please mark all out-of-level conditions that apply on this drawing as shown on the example on page 1. Measure each width or centerline (middle of threshold) as demonstrated by arrowed lines. Remember to allow for the body of the measuring tape.

Please Circle Panel Configuration
Door is universal, door swing is determined at installation.

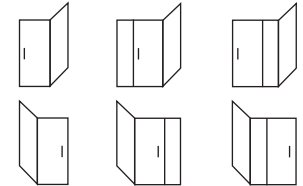

Ordering Information

Distributor Name: _____		Distributor Location: _____	
Distributor Contact: _____		Distributor Phone No: _____	
Purchase Order #/ Shipping Instructions: _____			
Basco Unit No: _____	Basco Unit Height: _____	Available Wall Height: _____	Glass Style: _____
Frame Color: _____	Unit List Price: _____		
Quick N' Stall Option: <input type="checkbox"/> Yes <input type="checkbox"/> No	Basco Part No(s): _____	Part(s) List Price: _____	
Fiberglass Make/ Model No: _____	Customer Name/ Comments: _____		
Installation Adders (Questions 6-10 apply exclusively to Retail.):			
1. No. of Additional Panels: _____	4. Additional Mileage (101 - 200 Miles): <input type="checkbox"/> Yes <input type="checkbox"/> No	6. Does unit have a special panel: <input type="checkbox"/> Yes <input type="checkbox"/> No	9. Glass to Glass Corner: <input type="checkbox"/> Yes <input type="checkbox"/> No
2. Removal: <input type="checkbox"/> Yes <input type="checkbox"/> No	5. Excess Mileage (in excess of 200 Miles): _____	7. No. of Additional Towel Bars: _____	10. Extreme Install: <input type="checkbox"/> Yes <input type="checkbox"/> No
3. Disposal: <input type="checkbox"/> Yes <input type="checkbox"/> No		8. Post to Ceiling: <input type="checkbox"/> Yes <input type="checkbox"/> No	

Measurements For Your Tub or Shower Door

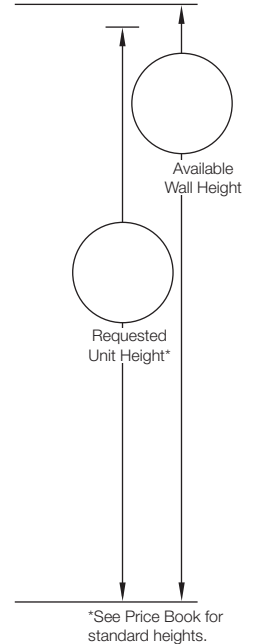
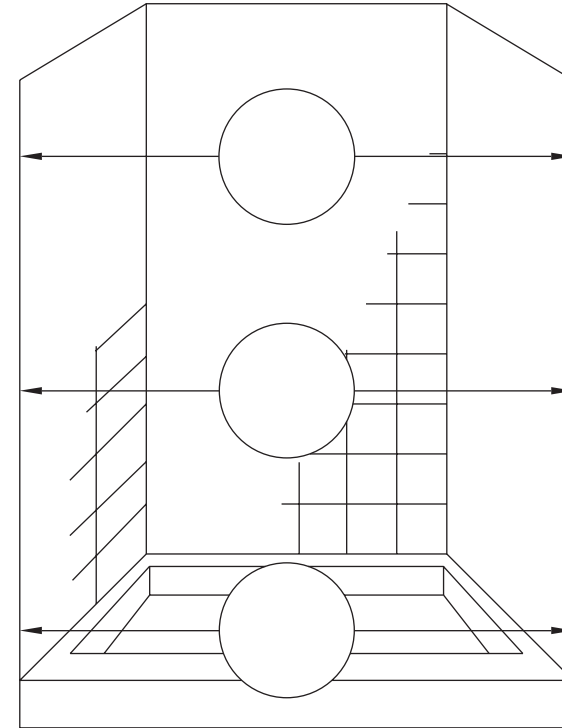
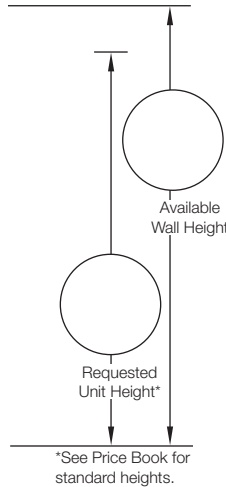
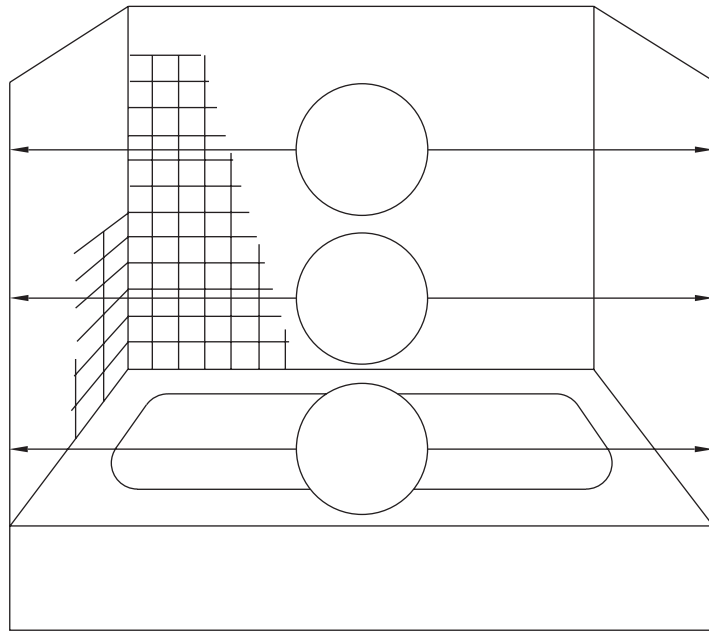
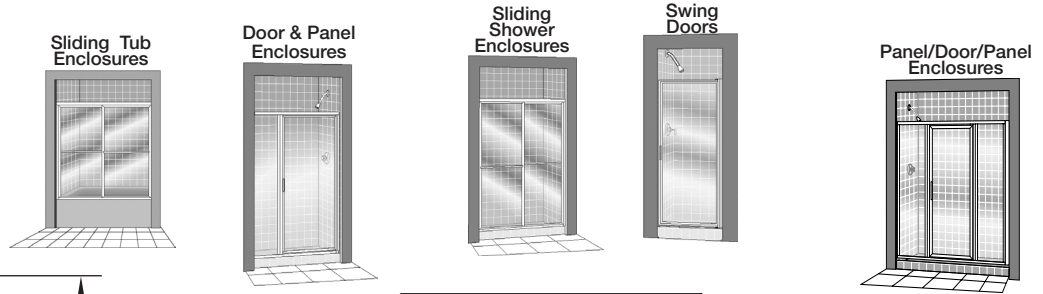

Most fiberglass units have a radius where the tub deck/threshold surface and wall meet. Please measure the bottom width approximately 1" above the tub deck/threshold surface.

Please mark all out-of-level conditions that apply on this drawing as shown on the example on page 1. Measure each width or centerline (middle of threshold) as demonstrated by arrowed lines. Remember to allow for the body of the measuring tape.

Ordering Information

Distributor Name: _____		Distributor Location: _____	
Distributor Contact: _____		Distributor Phone No: _____	
Purchase Order #/ Shipping Instructions: _____			
Basco Unit No: _____	Basco Unit Height: _____	Available Wall Height: _____	Glass Style: _____
Frame Color: _____	Unit List Price: _____		
Quick N' Stall Option: <input type="checkbox"/> Yes <input type="checkbox"/> No	Basco Part No(s): _____	Part(s) List Price: _____	
Fiberglass Make/ Model No: _____	Customer Name/ Comments: _____		
Installation Adders (Questions 6-10 apply exclusively to Retail.):			
1. No. of Additional Panels: _____	4. Additional Mileage (101 - 200 Miles): <input type="checkbox"/> Yes <input type="checkbox"/> No	6. Does unit have a special panel: <input type="checkbox"/> Yes <input type="checkbox"/> No	9. Glass to Glass Corner: <input type="checkbox"/> Yes <input type="checkbox"/> No
2. Removal: <input type="checkbox"/> Yes <input type="checkbox"/> No	5. Excess Mileage (in excess of 200 Miles): _____	7. No. of Additional Towel Bars: _____	10. Extreme Install: <input type="checkbox"/> Yes <input type="checkbox"/> No
3. Disposal: <input type="checkbox"/> Yes <input type="checkbox"/> No	8. Post to Ceiling: <input type="checkbox"/> Yes <input type="checkbox"/> No		



Design Your Basco Custom Tub or Shower

Please mark all out-of-level conditions that apply on this drawing as shown on the example on page 1. Measure each width or centerline (middle of threshold) as demonstrated by arrowed lines. Remember to allow for the body of the measuring tape.

Front View:

Top View:

<p>Grid for Front View drawing.</p>	<p>Grid for Top View drawing.</p>
-------------------------------------	-----------------------------------

Ordering Information

Distributor Name: _____		Distributor Location: _____	
Distributor Contact: _____		Distributor Phone No: _____	
Purchase Order #/ Shipping Instructions: _____			
Basco Unit No: _____	Basco Unit Height: _____	Available Wall Height: _____	Glass Style: _____
Frame Color: _____	Unit List Price: _____		
Quick N' Stall Option: <input type="checkbox"/> Yes <input type="checkbox"/> No	Basco Part No(s): _____	Part(s) List Price: _____	
Fiberglass Make/ Model No: _____	Customer Name/ Comments: _____		
Installation Adders (Questions 6-10 apply exclusively to Retail.):			
1. No. of Additional Panels: _____	4. Additional Mileage (101 - 200 Miles): <input type="checkbox"/> Yes <input type="checkbox"/> No	6. Does unit have a special panel: <input type="checkbox"/> Yes <input type="checkbox"/> No	9. Glass to Glass Corner: <input type="checkbox"/> Yes <input type="checkbox"/> No
2. Removal: <input type="checkbox"/> Yes <input type="checkbox"/> No	5. Excess Mileage (in excess of 200 Miles): _____	7. No. of Additional Towel Bars: _____	10. Extreme Install: <input type="checkbox"/> Yes <input type="checkbox"/> No
3. Disposal: <input type="checkbox"/> Yes <input type="checkbox"/> No	8. Post to Ceiling: <input type="checkbox"/> Yes <input type="checkbox"/> No		