



**CHRYSLER
SERVICE
INSTRUCTIONS**



BRIGGS & STRATTON TECHNOLOGIES

PRINTED IN U.S.A.

FORM MS-9900-6/93

INDEX

Key Detail	4
Depth & Spacing Detail	4
Tumbler Detail	5
Caps-N-Shutters	5
Coding Instructions	6
Ignitions	6-7
A) Module Ignition	
B) Tilt (Saginaw, Pivot Design)	
Doors	8
A) Pawl-n-Parts	
Rear Compartment & Tailgate	9
Cone Locks	9-10
Glove & Seat Back	11

CHRYSLER BODY CHART

	PLYMOUTH	DODGE	CHRYSLER	EAGLE
A	Acclaim	Spirit	Lebaron Landau (4 dr)	
B		Full Size Van		
BR		T-300		
J			Lebaron Coupe & Convertible	
LH		Intrepid	Concorde New Yorker 207	Vision
N		Dakota		
P	Sundance	Shadow		
PL	Neon	Neon		
S	Voyager	Caravan-Mini Ram Van		
SR	Viper			

In 1994 Chrysler has improved security in their Double-Bitted locking system. All 1994 vehicles will utilize a new key groove (84 primary, 85 valet), the change in key groove will initiate a keyway restricted valet system and new L-Series codes.

To continue giving your customers the quality service they're use to, the following should be noted when servicing the 1994 vehicles:

- Some new component parts have been added to the line, old component parts remain unchanged. (Tumblers, Caps, Shutters, Springs, Pawls, Shafts)
- New lock service packages will be required for ignitions and decks I/P and seat backs.

In fall 1993 Chrysler introduced its new PL vehicle (Plymouth Neon, Dodge Neon). These vehicles have the security change mentioned above and also are equipped with a new module style ignition. In the following pages you will find all service components and instructions needed to service all 1994 Chrysler locks.

KEY DETAIL

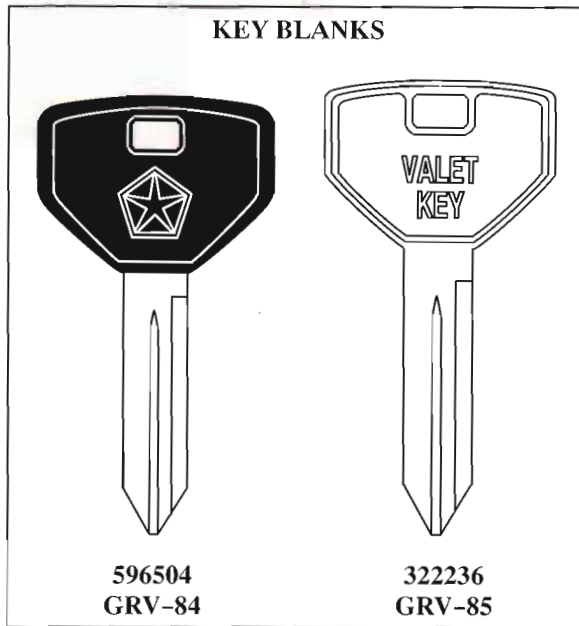

- 1.) Keys are double sided and reversible.
- 2.) Single key operation - using a master/valet function.
- 3.) Code Series:
 - A. The "L" codes will not be stamped on any of the locks.
 - B. A plastic bag with a bar coded paper label will accompany the car to the dealership.
- 4.) Please note that the X59 key cutting card **should not** be used when cutting the "L" codes. Please use X60 card.

KEY CODE	KEY BITTING	IGNITION	DOOR/DECK	TWIST I/P	I/P & SEATBACK
L0305	1244311	1244311	44311	4311	311
L0306	4332431	4332431	32431	2431	431
L0307	4344332	4344332	44332	4332	332
L0308	4311331	4311331	11331	1331	331
L0309	4422121	4422121	22121	2121	121
	3223431	3223431	23431	3431	
		1232131	32131		
		22222			

DEPTH AND SPACING DETAIL

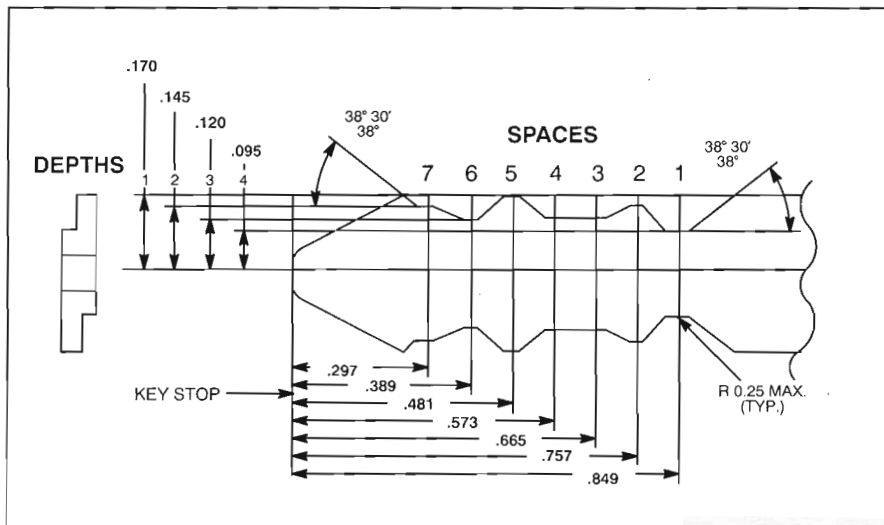

- 1.) The key is gauged from the tip of the key.
- 2.) Codes are listed bow to tip.
- 3.) Keys use 7 cuts and 4 depths.

TUMBLER DETAIL

DOUBLE THROW TUMBLER 1990 - CURRENT











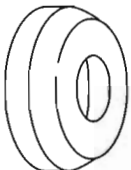
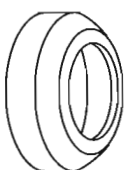

321761 - #1
321762 - #2
321763 - #3
321764 - #4
46890 - Springs

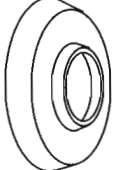
- 1.) Four tumblers are used that correspond to key cuts. 4 depths = 4 corresponding tumblers.
- 2.) All tumblers have numbers stamped on them.
- 3.) Tumblers are snap-in design.

IMPORTANT: Single Throw and double Throw Tumblers are **NOT** interchangeable. Use only with appropriate design.

CAPS-N-SHUTTERS

	SNAP CAP DOORS	SNAP CAP ILLUMINATED	SMALL CASE CAP DOORS & CONE LOCKS	LARGE CASE CAP REAR COMPT. LOCKS	UNIT SHUTTERS ALL	SHUTTER SPRINGS ALL	ZINC CASE CAP REAR COMP.
CHROME	 321504	 321830	 321847	 321709	 594753	 46766	 311446
BLACK	 321576		 321848	 321710	 594391	 46766	
SATIN BLACK			 322304				

CODING INSTRUCTIONS

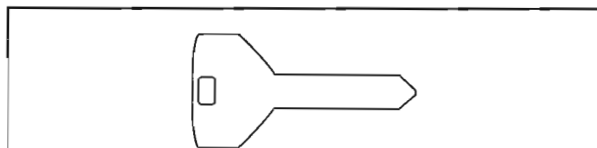

BITTING CHART

Lock Assembly	1	2	3	4	5	6	7	
Ignition	x	x	x	x	x	x	x	all 7 cuts
Door			x	x	x	x	x	last 5 cuts
Door (NEON only)		x	x	x	x	x	x	last 6 cuts
Rear Compartment			x	x	x	x	x	last 5 cuts
Glove Box					x	x	x	last 3 cuts
Seat Back					x	x	x	last 3 cuts

- 1.) Determine bitting of the MASTER KEY from code book or key.
- 2.) From the bitting chart, determine tumbler positions required for lock service.
- 3.) Install appropriate springs and tumblers.
- 4.) Snap into place.
- 5.) Test with MASTER key.

IGNITIONS

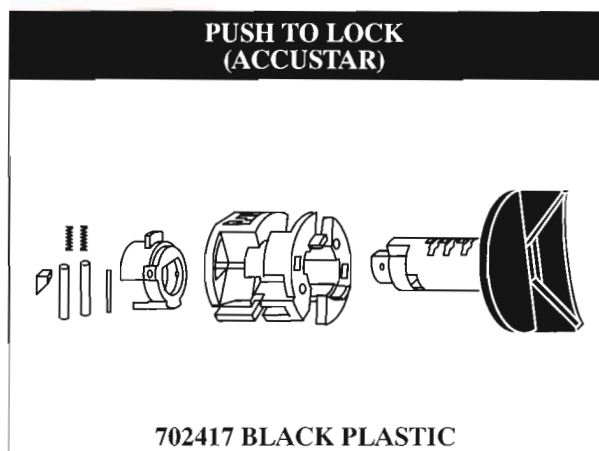

- 1.) Tumbler positions required 1 - 2 - 3 - 4 - 5 - 6 - 7.
- 2.) Sub-assemble detent pins & springs into housing assembly - set aside (face-up).
- 3.) See coding instructions.
- 4.) Insert buzzer actuator into lock cylinder with angled side towards the cylinder knob.
- 5.) Insert key into cylinder (slowly).
- 6.) Assembly
 - A. Hold lock cylinder with buzzer actuator on top in right hand.
 - B. Hold lock case with buzzer tab on top in left hand.
 - C. With buzzer actuator & buzzer tab aligned, slide lock cylinder into case until it stops (approximately 1/2 way).
 - D. Turn lock cylinder 45° counterclockwise & push in until it stops.
 - E. Turn lock cylinder 45° clockwise & push in until cylinder fully seats into lock case.
 - F. Hold cylinder knob down with thumb & remove key.
- 7.) Install driver & spirol pin.

IGNITIONS

MODULE IGNITION

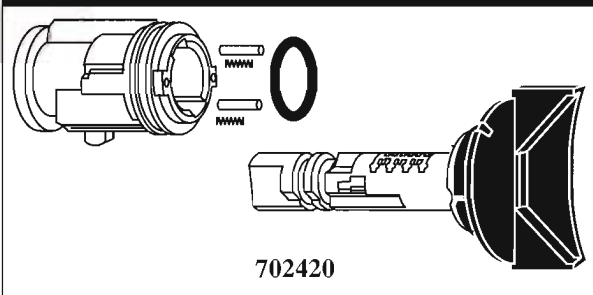

702420

- 3.) Sub-assemble springs & detent pins into lock case assembly – set aside (face up).
- 4.) See Coding instructions.
- 5.) Insert buzzer actuator into lock cylinder with long end of actuator facing down. Actuator should be flush with O.D. of cylinder.
- 6.) Insert key into cylinder slowly.
- 7.) Assembly

MODULE IGNITION

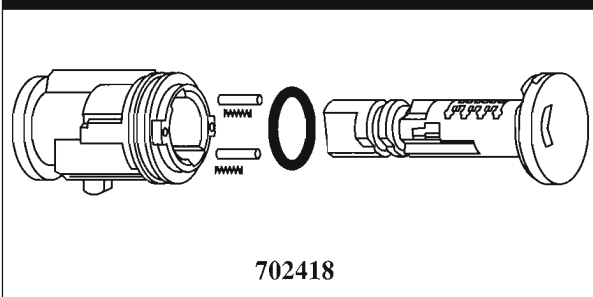

702418

- 1.) Tumbler positions required 1 - 2 - 3 - 4 - 5 - 6 - 7.
- 2.) Slide O-ring over front of lock case. Should seat in slot right behind detent hole bosses.

- A. Hold lock cylinder with buzzer actuator facing you (approximately 10 o'clock) in right hand.
- B. Hold lock case with retainer block facing away from you in left hand.
- C. Insert cylinder into lock case until cylinder seats against detent pins.
- D. Turn cylinder 45° clockwise.
- E. Turn key to run position, depress retainer block and insert into ignition module.

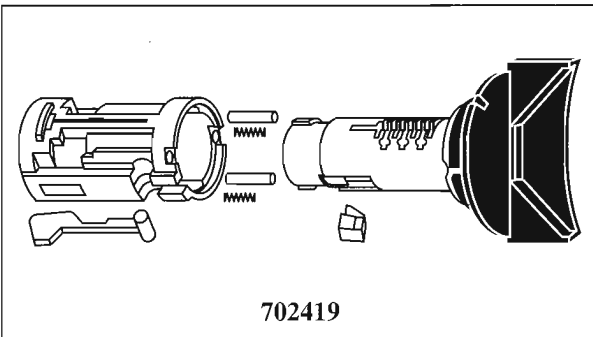

702419

- 1.) Tumbler positions required 1 - 2 - 3 - 4 - 5 - 6 - 7.
- 2.) See coding instructions.
- 3.) Slide buzzer actuator lever into lock case. Lever tip should protrude out from lock case.

- 4.) Sub-assemble springs & detent pins into housing assembly – set aside (face up).
- 5.) Insert buzzer actuator into lock cylinder. Actuator can only be installed one way.
- 6.) Insert key into cylinder slowly.
- 7.) Assembly
 - A. Hold lock cylinder with buzzer actuator facing you (approximately 10 o'clock) in right hand.
 - B. Hold lock case with buzzer actuator lever facing you (approximately 10 o'clock) in left hand.
 - C. Insert cylinder & key into lock case.
 - D. When cylinder is fully seated against detent pins, turn cylinder in the clockwise direction.

DOORS

STANDARD

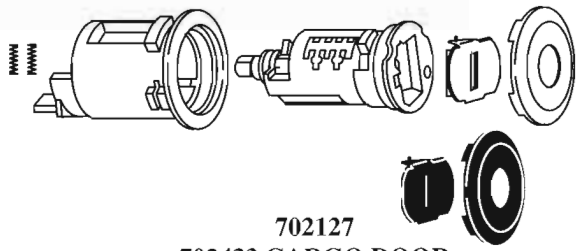

702127
702433 CARGO DOOR

SNAP-CAP

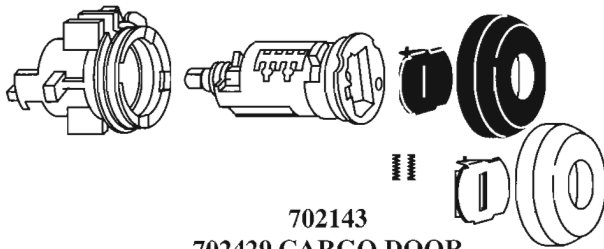

702143
702429 CARGO DOOR
702133 Illuminated
702498 NEON ONLY

- 1.) Tumbler positions required 1 - 2 - 3 - 4 - 5.
- 2.) See coding instructions.
- 3.) Install cylinder into lock case. (Note: Place return spring cavity in alignment with drain hole.)
- 4.) Place shutter springs 7 unit shutter on cylinder face and snap or stake on case cap.
- 5.) Install double-acting return spring.
- 6.) Install universal lock pawl & E-Clip for right hand or left hand application.

PAWLS-N-PARTS

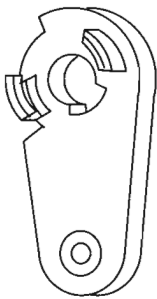

380946

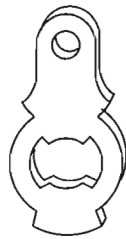

321570-FLAT



322210

321633-1.8 MM OFFSET
321732-7.7 MM OFFSET
321736-4.5 MM OFFSET
322110-2.2 MM OFFSET
321896 CARGO DOOR



46822

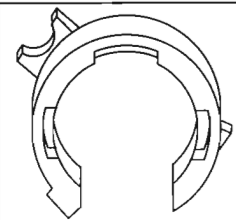

311166



93981

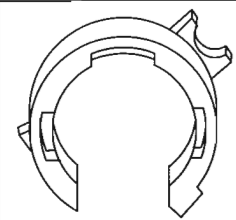

311167

REAR COMPARTMENT & TAILGATE

STANDARD W/LEVER

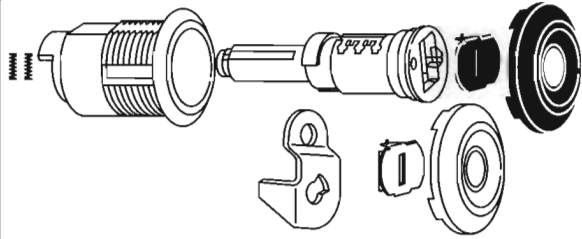

702421

STANDARD W/SHAFT

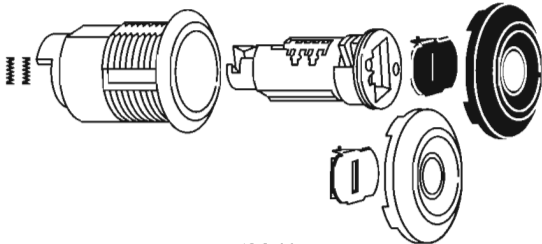

702425

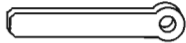

320930
VIPER

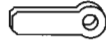

322074
VISION

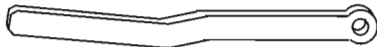

322102
INTREPID

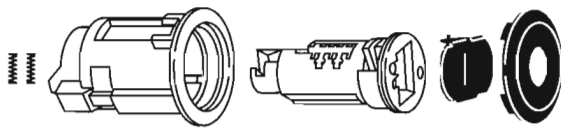

702422

- 1.) Tumbler positions required 3 - 4 - 5 - 6 - 7.
- 2.) See coding instructions.
- 3.) Hold lock case with drain hole at 6 o'clock. Insert cylinder & key into case with return spring groove at 3 o'clock.
- 4.) Turn cylinder counterclockwise until it stops & remove key.
- 5.) Place shutter springs & unit shutter on cylinder face & stake on case cap.
- 6.) Install lock cylinder into cone housing (if applicable).
- 7.) Install return spring. 
- 8.) Install lever or shaft.

NEW YORKER

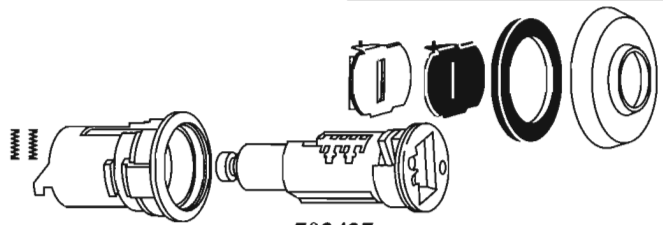

702427

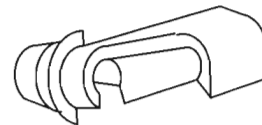

380942

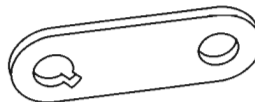

322155

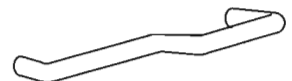

46948

CONE LOCKS

SUNDANCE AND SHADOW

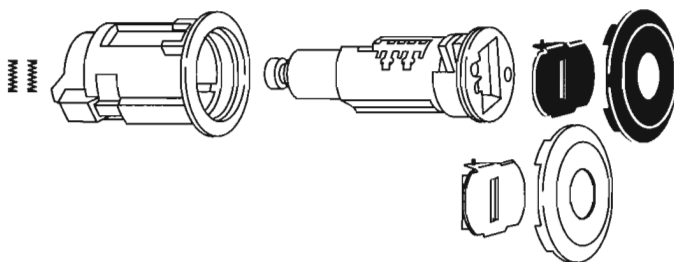

702424

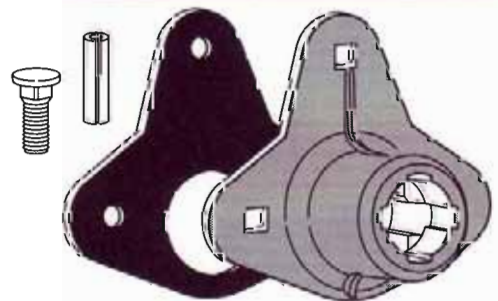

701241

CONE LOCKS (Cont'd.)

NEON

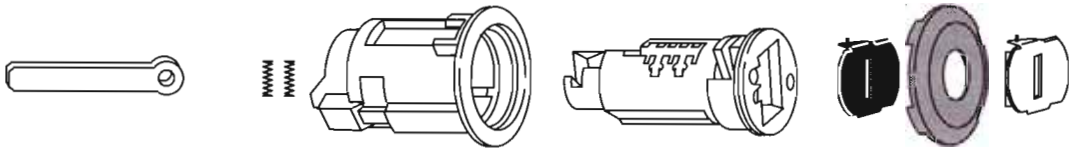

702422

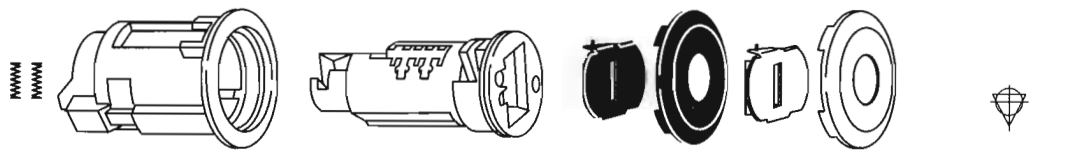

702423



321460

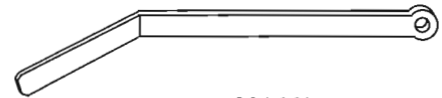

321661

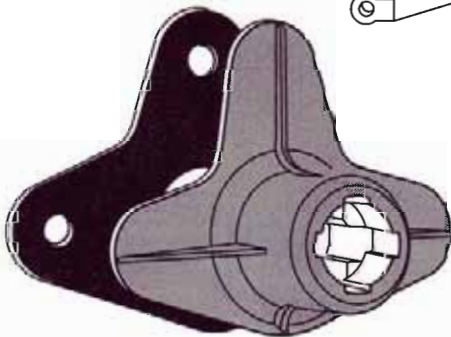

701243
Lebaron Coupe

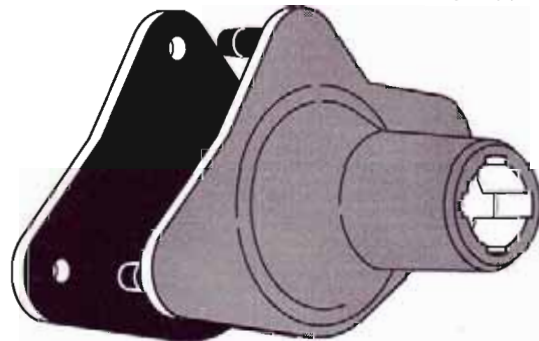

701244
Acclaim Spirit Lebaron

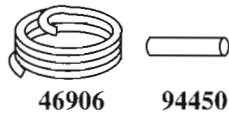

46906 94450

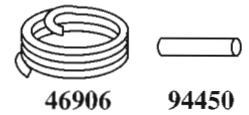

46906 94450

CONCORDE

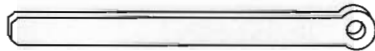

322127

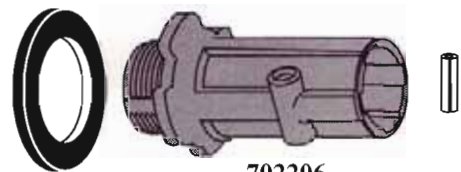

702206

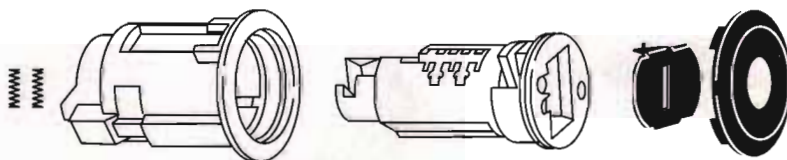

702591



46906

GLOVE - SEAT BACK

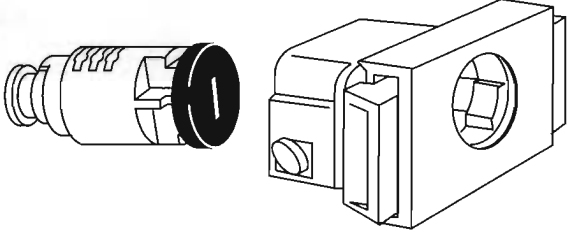
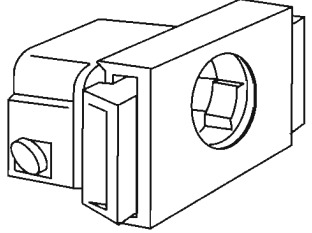
SQUEEZE GLOVE	
	
596750-BLACK 596749-CHROME	700924

Remove cylinder by spreading the two tabs on the back side of the squeeze latch.

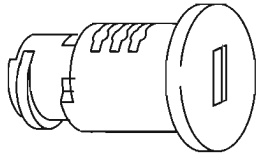
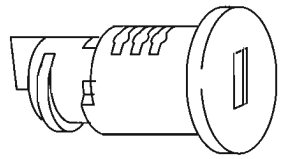









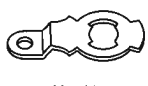
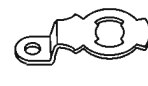













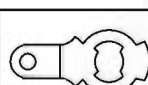



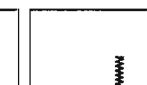

PADDLE GLOVE	SEAT BACK
	
596742 596751 INTREPID CONCORDE VISION NEW YORKER	596755

Remove cylinder by depressing retainer on the back of the cylinder recode and reinstall.

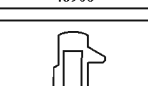
NOTE: All new Glove and Seat Back Cylinders will use Double Throw Tumblers, even though all tumblers are located on one side of the cylinder.

- 1.) Tumbler positions required 5 - 6 - 7.
- 2.) See coding instructions.

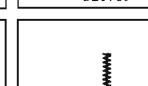
COMPLETE SERVICE KIT B&S PART #701417

 321732	 321736	 321570			
 321761	 321762	 321763	 321764	 321848	 321848
 321504	 321504	 321576	 321576	 321847	 321847
 46822	 321633	 93981	 594753	 594391	 46766
 46906	 321710	 321710	 321709	 321709	
 321491	 321492	 321493	 321494	 46890	 94508

NOTE: IF YOU HAVE ALREADY PURCHASED A 700918 SERVICE KIT, SIMPLY ORDER UPDATE KIT #701416 TO RECEIVE ALL THE NEW PARTS. (700918 & 701416=701417)

ALL PARTS MAYBE ORDERED INDIVIDUALLY-FOR REFILL PURPOSES