



**INDUSTRIAL
FAN CATALOG**

TABLE OF CONTENTS

<i>Introduction</i>	<i>2</i>	<i>20" and 18" Industrial Grade Fans</i>	<i>10</i>
<i>Industrial Grade Drum Fans</i>	<i>3</i>	<i>Industrial Grade Multi Mount Fans</i>	<i>11</i>
<i>Industrial Grade Quiet Pedestal Fan</i>	<i>4</i>	<i>Industrial Grade Floor Fans</i>	<i>12</i>
<i>Industrial Grade Quiet Wall Mount Fans</i>	<i>5</i>	<i>Government Fans</i>	<i>13</i>
<i>1/3 HP Industrial Grade Fan Components</i>	<i>6</i>	<i>Pivoting Blowers</i>	<i>14</i>
<i>1/3 HP Industrial Grade Air Circulators</i>	<i>7</i>	<i>Window Fans</i>	<i>14</i>
<i>1/4 HP Industrial Grade Fan Components</i>	<i>8</i>	<i>Index</i>	<i>15</i>
<i>1/4 HP Industrial Grade Air Circulators</i>	<i>9</i>		

VALUE, QUALITY, AND SERVICE

As a leading supplier of Industrial and Commercial Grade Air Circulators, Air King is recognized throughout the industry for the superior quality and performance of its products. Our four North American manufacturing facilities ensure every Air King fan is precision-designed, engineered, and tested to meet the high standards our customers have come to expect. We strive every day to exceed our customers' expectations for Value, Service and Quality. Our product design team is constantly working to develop new products to meet the changing needs of today's market place while also keeping our existing products the leader's in the industry. In this way Air King ensures that our customers are always offered the right product at the right price.

PRODUCTS THAT EXCEED YOUR EXPECTATIONS

From Industrial to Commercial Grade fans, Wall Mounts to Pivoting Air Circulators, Air King offers a full line of fans to meet your needs for the workplace. Every Air King fan features a permanently lubricated motor to provide maintenance-free operation and are rigorously tested prior to shipping to provide high volume air movement with years of trouble-free operation. Every fan features a three-wire grounded plug and cord; and fan guards that meet with OSHA requirements. Air King warrants motors for three years, all other fan parts have a one year warranty.

THE AIR KING DIFFERENCE

Customer service is a title that everyone in our company shares. From our corporate staff to our nationwide network of manufacturer's representatives, we are dedicated to making sure your questions are addressed and answered quickly and accurately.



INDUSTRIAL GRADE DRUM FANS

When the goal is to move a large amount of air, the Air King Drum Fans are the perfect solution.

PRODUCT INFORMATION

Motor

2-speed, 1/3 HP, 120V, 1 phase, ball bearing, permanently lubricated, permanent split capacitor (models 9936D, 9942D)

2-speed, 1/2 HP, 120V, 1 phase, ball bearing, permanently lubricated, permanent split capacitor (models 9236D)

Controls

Side mounted switch

Power Cord

Black, 10', 3-conductor, SJT type

Coating

Blade, Guard, and Mounts are powder coated steel

Compliance

ETL, OSHA

Belt Drive
9942D, 9936D



Direct Drive
9236D



SPECIFICATIONS

MODEL	DESCRIPTION	BLADE SIZE	PRODUCT DIMENSIONS	WEIGHT (LBS.)	CUBE (FEET)	LIST PRICE
9942D	42" Belt Driven Drum Fan	42"	47"L x 19"W x 45"H	93.0	23.90	\$650.00
9936D	36" Belt Driven Drum Fan	36"	40"L x 20"W x 40.5"H	75.0	18.75	\$600.00
9236D	36" Direct Drive Drum Fan		38"L x 16"W x 40.5"H	61.0	14.25	\$550.00

PERFORMANCE

MODEL	TYPE	CFM		RPM		AMPS		WATTS		DB A	
		HIGH	LOW	HIGH	LOW	HIGH	LOW	HIGH	LOW	HIGH	LOW
9942D	42" 1/3 HP	13000	8600	490	320	6.50	3.80	460	235	68	58
9936D	36" 1/3 HP	9200	6000	575	380	6.50	3.70	440	230	62	55
9236D	36" 1/2 HP	10900	7850	1120	805	6.60	5.70	725	565	78	66

Specifications are subject to change.



INDUSTRIAL GRADE QUIET PEDESTAL FANS

Industrial Grade Quiet Pedestal Fans provide the perfect solution for spaces that need high volume air movements while still being quiet. Perfect for churches, banquet halls, auditoriums, and other large spaces.

The Quiet Pedestal Fans incorporate a quiet speed into the controls of the fan. This quiet speed allows the fan to operate at a reduced sound level, while still delivering powerful air circulation. For times when additional power is needed, the fan can be operated using the other speeds.

PRODUCT INFORMATION

Motor

3-speed, 1/4 HP, 120V, 1 phase, totally enclosed, ball bearing, permanently lubricated, permanent split capacitor

Controls

Rear mounted pull cord switch

Power Cord

Black, 10', 3-conductor, SJT type

Coating

Blade, Guard, and Mounts are powder coated steel

Compliance

ETL, OSHA

Height

Adjustable from 60" to 84" (model 99532)

Adjustable from 57" to 81" (model 99533)

Oscillation

90°



30" Quiet Pedestal Fan
99532

24" Quiet Pedestal Fan
99533



SPECIFICATIONS

MODEL	DESCRIPTION	BLADE SIZE	PRODUCT DIMENSIONS	WEIGHT (LBS.)	CUBE (FEET)	LIST PRICE
99532	30" Quiet, Oscillating Pedestal Fan	30"	33.5"L x 29.5"W x 84"H	70.0	6.03	\$505.00
99533	24" Quiet, Oscillating Pedestal Fan	24"	29.5"L x 29.5"W x 81"H	66.4	8.26	\$495.00

PERFORMANCE

MODEL	TYPE	CFM			RPM			AMPS			WATTS			DB A		
		HIGH	MED	QUIET	HIGH	MED	QUIET	HIGH	MED	QUIET	HIGH	MED	QUIET	HIGH	MED	QUIET
99532	30" 1/4 HP	7450	6090	3450	1010	860	530	2.2	1.6	0.6	245	185	70	68	64	50
99533	24" 1/4 HP	5030	4320	2280	1025	880	480	2.0	1.6	0.6	250	190	70	69	65	48

Tested in accordance with AMCA standard 230-99. • Specifications are subject to change.

* Decibels (DBA) on quiet speed is at least 10 decibels less than traditional fans. An increase of 10 decibels is perceived to be approximately twice as loud



INDUSTRIAL GRADE QUIET WALL MOUNTED FANS

Industrial Grade Quiet Wall Mount Fans provide the perfect solution for areas with limited floor space that need high volume air movements while still being quiet. Perfect for churches, banquet halls, auditoriums, and other large spaces.

The Quiet Wall Mount Fans incorporate a quiet speed into the controls of the fan. This quiet speed allows the fan to operate at a reduced sound level, while still delivering powerful air circulation. For times when additional power is needed, the fan can be operated using the other speeds.

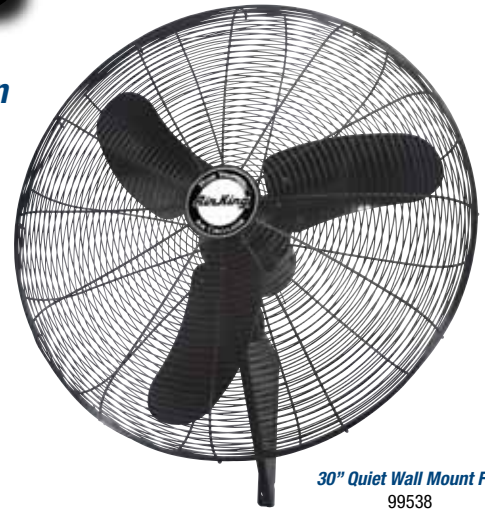

30" Quiet Wall Mount Fan
99538

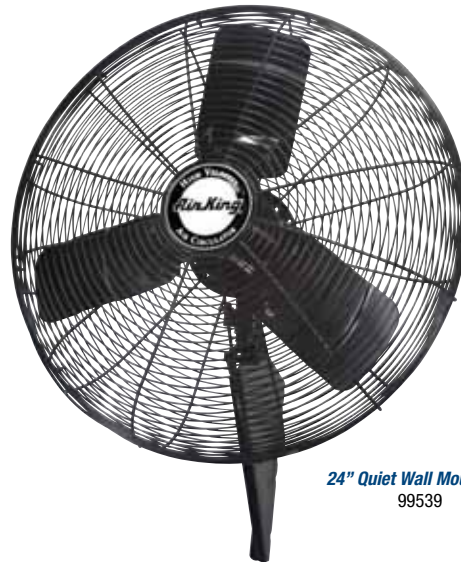

24" Quiet Wall Mount Fan
99539

PRODUCT INFORMATION

Motor

3-speed, 1/4 HP, 120V, 1 phase, totally enclosed, ball bearing, permanently lubricated, permanent split capacitor

Controls

Rear mounted pull cord switch

Power Cord

Black, 10', 3-conductor, SJT type

Coating

Blade, Guard, and Mounts are powder coated steel

Compliance

ETL, OSHA

Oscillation

90°



SPECIFICATIONS						
MODEL	DESCRIPTION	BLADE SIZE	PRODUCT DIMENSIONS	WEIGHT (LBS.)	CUBE (FEET)	LIST PRICE
99538	30" Quiet, Oscillating Wall Mount Fan	30"	33.5"L x 24"W x 33.5"H	53.5	6.03	\$410.00
99539	24" Quiet, Oscillating Wall Mount Fan	24"	27"L x 24"W x 27"H	49.5	8.26	\$400.00

PERFORMANCE																
MODEL	TYPE	CFM			RPM			AMPS			WATTS			DB A		
		HIGH	MED	QUIET	HIGH	MED	QUIET	HIGH	MED	QUIET	HIGH	MED	QUIET	HIGH	MED	QUIET
99538	30" 1/4 HP	7450	6090	3450	1010	860	530	2.2	1.6	0.6	245	185	70	68	64	50
99539	24" 1/4 HP	5030	4320	2280	1025	880	480	2.0	1.6	0.6	250	190	70	69	65	48

Tested in accordance with AMCA standard 230-99. • Specifications are subject to change.



1/3 HP INDUSTRIAL GRADE FAN COMPONENTS

Industrial Grade Fan Components allow the freedom to customize to suit your needs and reduce your assembly time and cost.

PRODUCT INFORMATION

Motor

3-speed, 1/3 HP, 120V, 1 phase, totally enclosed, ball bearing, permanently lubricated, permanent split capacitor

Controls

Rear mounted pull cord switch

Power Cord

Black, 10', 3-conductor, SJT type

Coating

Blade, Guard, and Mounts are powder coated steel

Compliance

ETL, OSHA

Oscillation

90° (models 9174H, 9175H)

Assembled Head
9170H, 9175H

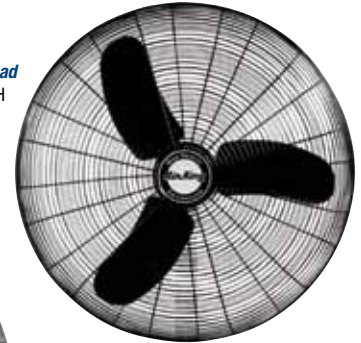

Assembled Head
9171H, 9174H

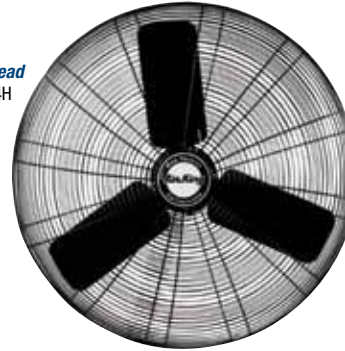

Wall Mount
9100WC



Pedestal Pole & Base
9100PB



I-Beam Mount
9100i

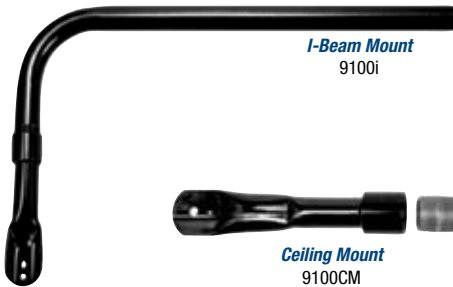

Ceiling Mount
9100CM



Pedestal Wheel Kit
9100WB



SPECIFICATIONS

MODEL	DESCRIPTION	BLADE SIZE	PRODUCT DIMENSIONS	WEIGHT (LBS.)	CUBE (FEET)	LIST PRICE
9170H	30" Assembled Head	30"	33.5"L x 17.5"W x 33.5"H	53.7	10.56	\$372.50
9175H	30" Assembled Oscillating Head		33.5"L x 17.5"W x 33.5"H	56.3	10.56	\$395.00
9171H	24" Assembled Head	24"	27"L x 17.5"W x 27"H	46.8	6.96	\$352.50
9174H	24" Assembled Oscillating Head		27"L x 17.5"W x 27"H	47.2	6.96	\$372.50
9100PB	Pedestal Pole & Base	N/A	30"L x 30"W x 42.5"H	31.4	1.04	\$140.00
9100WC	Wall Mounting Bracket	N/A	13"L x 2"W x 12.5"H	5.3	.19	\$40.00
9100CM	Ceiling Mounting Bracket	N/A	4.5"L x 4.5"W x 15"H	3.6	.28	\$75.00
9100i	I-Beam Mounting Bracket	N/A	32.5"L x 2"W x 21"H	9.8	.78	\$187.50
9100WB	Pedestal Wheel Kit (4" diameter)	N/A	4"L x 4"W x 9"H	2.2	.36	\$40.00

PERFORMANCE

TYPE	CFM			RPM			AMPS			WATTS			DB A		
	HIGH	MED	LOW	HIGH	MED	LOW	HIGH	MED	LOW	HIGH	MED	LOW	HIGH	MED	LOW
30" 1/3 HP ¹	8780	7480	5570	1075	925	800	2.8	2.0	1.65	308	205	170	72	70	64
24" 1/3 HP ²	5770	5250	4270	1054	869	673	2.5	1.96	1.40	332	226	152	69	67	59

¹ Includes models 9170H, 9175H • ² Includes models 9171H, 9174H

Tested in accordance with AMCA standard 230-99. • Specifications are subject to change.



1/3 HP INDUSTRIAL GRADE AIR CIRCULATORS

Ideal for plants, warehouses, large offices, and other industrial spaces that require powerful air circulation

PRODUCT INFORMATION

Motor

3-speed, 1/3 HP, 120V, 1 phase, totally enclosed, ball bearing, permanently lubricated, permanent split capacitor

Controls

Rear mounted pull cord switch

Power Cord

Black, 10', 3-conductor, SJT type

Coating

Blade, Guard, and Mounts are powder coated steel

Compliance

ETL, OSHA

Height

Adjustable from 64" to 90" (models 9170, 9175)

Adjustable from 61" to 88" (models 9171, 9174)

Oscillation

90° (models 9174, 9175, 9074, 9075, 9374, 9375, 9674, 9675)

Fans are shipped unassembled in one UPS shippable carton

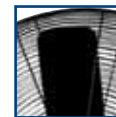

24" models utilize our traditional rectangular designed fan blade

Pedestal

9170, 9175, 9171, 9174

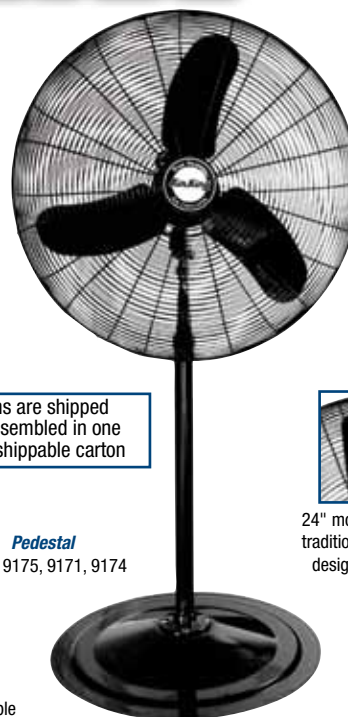

Secondary support cable included on Wall, Ceiling, and I-Beam Mount models.



Wall Mount

9070, 9075, 9071, 9074



Ceiling Mount

9370, 9375, 9371, 9374



I-Beam Mount

9670, 9675, 9671, 9674

SPECIFICATIONS

	MODEL	DESCRIPTION	BLADE SIZE	PRODUCT DIMENSIONS	WEIGHT (LBS.)	CUBE (FEET)	LIST PRICE
PEDESTAL	9170	30" Pedestal Fan	30"	33.5"L x 29"W x 90"H	80.0	6.03	\$450.00
	9175	30" Oscillating Pedestal Fan	30"	33.5"L x 29"W x 90"H	82.6	6.03	\$470.00
	9171	24" Pedestal Fan	24"	27"L x 29"W x 88"H	73.5	8.26	\$430.00
	9174	24" Oscillating Pedestal Fan	24"	27"L x 29"W x 88"H	76.1	8.26	\$450.00
WALL	9070	30" Wall Mounted Fan	30"	33.75"L x 25.75"W x 38.75"H	44.9	6.03	\$375.00
	9075	30" Oscillating Wall Mount Fan	30"	33.75"L x 25.75"W x 38.75"H	46.6	6.03	\$395.00
	9071	24" Wall Mounted Fan	24"	26.75"L x 25"W x 34.5"H	38.4	8.26	\$355.00
	9074	24" Oscillating Wall Mount Fan	24"	26.75"L x 25"W x 34.5"H	40.1	8.26	\$375.00
CEILING	9370	30" Ceiling Mount Fan	30"	33.5"L x 29"W x 36.75"H	42.9	6.03	\$415.00
	9375	30" Oscillating Ceiling Mount Fan	30"	33.5"L x 29"W x 36.75"H	44.9	6.03	\$437.50
	9371	24" Ceiling Mount Fan	24"	27"L x 29"W x 33.63"H	36.7	8.26	\$395.00
	9374	24" Oscillating Ceiling Mount Fan	24"	27"L x 29"W x 33.63"H	38.4	8.26	\$415.00
I-BEAM	9670	30" I-Beam Mount Fan	30"	42"L x 33"W x 44"H	77.3	6.03	\$515.00
	9675	30" Oscillating I-Beam Mount Fan	30"	42"L x 33"W x 44"H	81.7	6.03	\$530.00
	9671	24" I-Beam Mount Fan	24"	41"L x 27"W x 41"H	70.8	8.26	\$490.00
	9674	24" Oscillating I-Beam Mount Fan	24"	41"L x 27"W x 41"H	75.2	8.26	\$515.00

PERFORMANCE

TYPE	CFM			RPM			AMPS			WATTS			DB A		
	HIGH	MED	LOW	HIGH	MED	LOW	HIGH	MED	LOW	HIGH	MED	LOW	HIGH	MED	LOW
30" 1/3 HP ¹	8780	7480	5570	1075	925	800	2.8	2.0	1.65	308	205	170	72	70	64
24" 1/3 HP ²	5770	5250	4270	1054	869	673	2.5	1.96	1.40	332	226	152	69	67	59

¹ Includes models 9170, 9175, 9070, 9075, 9370, 9375, 9670, 9675 • ² Includes models 9171, 9174, 9071, 9074, 9371, 9374, 9671, 9674
Tested in accordance with AMCA standard 230-99. • Specifications are subject to change.



1/4 HP INDUSTRIAL GRADE FAN COMPONENTS

Industrial Grade Fan Components allow the freedom to customize to suit your needs and reduce your assembly time and cost.

PRODUCT INFORMATION

Motor

3-speed, 1/4 HP, 120V, 1 phase, totally enclosed, ball bearing, permanently lubricated, permanent split capacitor

Controls

Rear mounted pull cord switch

Power Cord

Black, 10', 3-conductor, SJT type

Coating

Blade, Guard, and Mounts are powder coated steel

Compliance

ETL, OSHA

Oscillation

90° (models 9135H, 9125H)

Assembled Head
9130H, 9135H, 9124H,
9125H, 9120H, 9121H

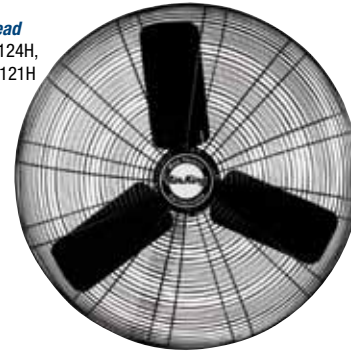

I-Beam Mount
9100i



Ceiling Mount
9100CM



Wall Mount
9100WC



Pedestal Wheel Kit
9100WB



Pedestal Pole & Base
9100PB



SPECIFICATIONS

MODEL	DESCRIPTION	BLADE SIZE	PRODUCT DIMENSIONS	WEIGHT (LBS.)	CUBE (FEET)	LIST PRICE
9130H	30" Assembled Head	30"	33.5"L x 16.5"W x 33.25"H	53.7	10.56	\$330.00
9135H	30" Assembled Oscillating Head		33.5"L x 16.5"W x 33.25"H	56.3	10.56	\$355.00
9124H	24" Assembled Head	24"	27"L x 16.5"W x 27"H	46.8	6.96	\$310.00
9125H	24" Assembled Oscillating Head		27"L x 16.5"W x 27"H	47.2	6.96	\$330.00
9120H	20" Assembled Head	20"	23.5"L x 15"W x 23.5"H	29.8	6.87	\$290.00
9121H	20" Assembled Oscillating Head		23.5"L x 15"W x 23.5"H	31.6	6.87	\$320.00
9100PB	Pedestal Pole & Base	N/A	30"L x 30"W x 42.5"H	31.4	1.04	\$140.00
9100WC	Wall Mounting Bracket	N/A	13"L x 2"W x 12.5"H	5.3	.19	\$40.00
9100CM	Ceiling Mounting Bracket	N/A	4.5"L x 4.5"W x 15"H	3.6	.28	\$75.00
9100i	I-Beam Mounting Bracket	N/A	32.5"L x 2"W x 21"H	9.8	.78	\$187.50
9100WB	Pedestal Wheel Kit (4" diameter)	N/A	4"L x 4"W x 9"H	2.2	.36	\$40.00

PERFORMANCE

TYPE	CFM			RPM			AMPS			WATTS			DB A		
	HIGH	MED	LOW	HIGH	MED	LOW	HIGH	MED	LOW	HIGH	MED	LOW	HIGH	MED	LOW
30" 1/4 HP ¹	7400	6360	4980	1040	902	860	2.40	1.86	1.46	255	200	154	75	71	67
24" 1/4 HP ²	5130	4490	3670	1060	925	745	2.39	1.86	1.52	252	199	157	72	69	64
20" 1/4 HP ³	3960	3630	3020	1061	956	747	2.39	1.86	1.52	248	201	161	64	61	55

¹ Includes models 9170H, 9175H • ² Includes models 9171H, 9174H • ³ Includes model 9020H, 9121H
Tested in accordance with AMCA standard 230-99. • Specifications are subject to change.



1/4 HP INDUSTRIAL GRADE AIR CIRCULATORS

Ideal for plants, warehouses, large offices, and other industrial spaces that require powerful air circulation

PRODUCT INFORMATION

Motor

3-speed, 1/4 HP, 120V, 1 phase, totally enclosed, ball bearing, permanently lubricated, permanent split capacitor

Controls

Rear mounted pull cord switch

Power Cord

Black, 10', 3-conductor, SJT type

Coating

Blade, Guard, and Mounts are powder coated steel

Compliance

ETL, OSHA

Height

Adjustable from 64" to 90" (models 9130, 9135)

Adjustable from 61" to 88" (models 9124, 9125)

Oscillation

90° (models 9135, 9125, 9035, 9025, 9335, 9325, 9635, 9625)

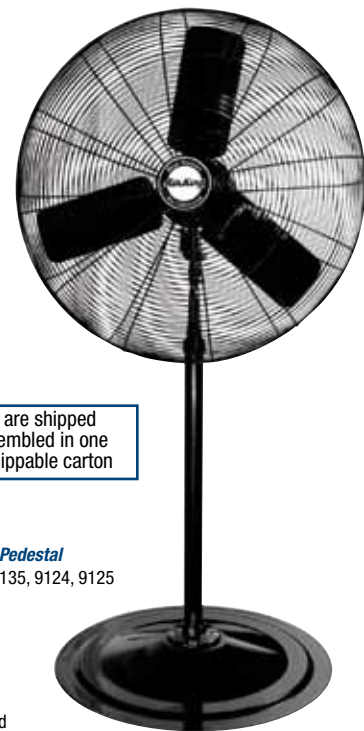

Fans are shipped unassembled in one UPS shippable carton

Pedestal

9130, 9135, 9124, 9125



Secondary support cable included on Wall, Ceiling, and I-Beam Mount models.



Wall Mount

9030, 9035, 9024, 9025



Ceiling Mount

9330, 9335, 9724, 9325



I-Beam Mount

9430, 9635, 9424, 9625

SPECIFICATIONS

	MODEL	DESCRIPTION	BLADE SIZE	PRODUCT DIMENSIONS	WEIGHT (LBS.)	CUBE (FEET)	LIST PRICE
PEDESTAL	9130	30" Pedestal Fan	30"	33.5"L x 29"W x 90"H	80.0	6.03	\$430.00
	9135	30" Oscillating Pedestal Fan	30"	33.5"L x 29"W x 90"H	82.6	6.03	\$450.00
	9124	24" Pedestal Fan	24"	27"L x 29"W x 88"H	73.5	8.26	\$405.00
	9125	24" Oscillating Pedestal Fan	24"	27"L x 29"W x 88"H	76.1	8.26	\$430.00
WALL	9030	30" Wall Mounted Fan	30"	33.75"L x 25.75"W x 38.75"H	44.9	6.03	\$355.00
	9035	30" Oscillating Wall Mount Fan	30"	33.75"L x 25.75"W x 38.75"H	46.6	6.03	\$375.00
	9024	24" Wall Mounted Fan	24"	26.75"L x 25"W x 34.5"H	38.4	8.26	\$330.00
	9025	24" Oscillating Wall Mount Fan	24"	26.75"L x 25"W x 34.5"H	40.1	8.26	\$355.00
CEILING	9330	30" Ceiling Mount Fan	30"	33.5"L x 29"W x 36.75"H	42.9	6.03	\$395.00
	9335	30" Oscillating Ceiling Mount Fan	30"	33.5"L x 29"W x 36.75"H	44.9	6.03	\$415.00
	9724	24" Ceiling Mount Fan	24"	27"L x 29"W x 33.63"H	36.7	8.26	\$375.00
	9325	24" Oscillating Ceiling Mount Fan	24"	27"L x 29"W x 33.63"H	38.4	8.26	\$400.00
I-BEAM	9430	30" I-Beam Mount Fan	30"	42"L x 33"W x 44"H	77.3	6.03	\$490.00
	9635	30" Oscillating I-Beam Mount Fan	30"	42"L x 33"W x 44"H	79.9	6.03	\$515.00
	9424	24" I-Beam Mount Fan	24"	41"L x 27"W x 41"H	70.8	8.26	\$470.00
	9625	24" Oscillating I-Beam Mount Fan	24"	41"L x 27"W x 41"H	74.2	8.26	\$490.00

PERFORMANCE

TYPE	CFM			RPM			AMPS			WATTS			DB A		
	HIGH	MED	LOW	HIGH	MED	LOW	HIGH	MED	LOW	HIGH	MED	LOW	HIGH	MED	LOW
30" 1/4 HP ¹	7400	6360	4980	1040	902	860	2.40	1.86	1.46	255	200	154	75	71	67
24" 1/4 HP ²	5130	4490	3670	1060	925	745	2.39	1.86	1.52	252	199	157	72	69	64

¹ Includes models 9130, 9135, 9030, 9035, 9330, 9335, 9430, 9635 • ² Includes models 9124, 9125, 9024, 9025, 9724, 9325, 9424, 9625
Tested in accordance with AMCA standard 230-99. • Specifications are subject to change.



20" and 18" INDUSTRIAL GRADE FANS

Ideal for gyms, auditoriums, schools, churches and industrial spaces that need powerful air circulation.

PRODUCT INFORMATION

Motor

3-speed, 1/6 HP, 120V, 1 phase, totally enclosed, ball bearing, permanently lubricated, permanent split capacitor

Controls

Rear mounted rotary switch (models 9420, 9418)

Rear mounted pull cord switch (models 9020, 9518, 9320 9718, 9520, 9618)

Power Cord

Black, 9', 3-conductor, SJT type

Coating

Blade, Guard, and Mounts are powder coated steel

Compliance

ETL, OSHA

Height

Adjustable from 54" to 64" (model 9420)

Adjustable from 52" to 62" (model 9418)



Pedestal
9420



Pedestal
9418



Secondary support cable included on Wall, Ceiling, and I-Beam Mount models.



Wall Mount
9020

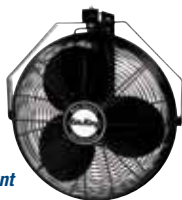

Wall Mount
9518



Ceiling Mount
9320



Ceiling Mount
9718



I-Beam Mount
9520



I-Beam Mount
9618

SPECIFICATIONS

MODEL	DESCRIPTION	BLADE SIZE	PRODUCT DIMENSIONS	WEIGHT (LBS.)	CUBE (FEET)	LIST PRICE
9420	20" Pedestal Fan	20"	26.5"L x 23.25"W x 64"H	34.3	3.76	\$240.00
9020	20" Wall Mount Fan		26.5"L x 16.5"W x 29.5"H	26.0	3.47	\$190.00
9320	20" Ceiling Mount Fan		26.5"L x 10.5"W x 29.5"H	23.7	3.47	\$240.00
9520	20" I-Beam Mount Fan	18"	36"L x 22"W x 42"H	47.6	3.47	\$325.00
9418	18" Pedestal Fan		24"L x 24"W x 62"H	31.4	3.25	\$240.00
9518	18" Wall Mount Fan		24"L x 16.5"W x 28"H	24.8	2.80	\$190.00
9718	18" Ceiling Mount Fan		24"L x 10.5"W x 28"H	23.1	2.80	\$240.00
9618	18" I-Beam Mount Fan		24"L x 37.5"W x 38.5"H	36.9	4.90	\$325.00

PERFORMANCE

TYPE	CFM			RPM			AMPS			WATTS			DB A		
	HIGH	MED	LOW	HIGH	MED	LOW	HIGH	MED	LOW	HIGH	MED	LOW	HIGH	MED	LOW
20" 1/6 HP ⁴	3670	3330	2940	1500	1310	1050	1.60	1.30	1.10	184	155	130	62	55	48
18" 1/6 HP ⁵	3190	2970	2660	1500	1300	1100	1.52	1.30	1.00	180	150	125	67	58	49

⁴ Includes models 9420, 9020, 9320, 9520 • ⁵ Includes models 9418, 9518, 9718, 9618
Tested in accordance with AMCA standard 230-99. • Specifications are subject to change.



INDUSTRIAL-GRADE MULTI MOUNT FANS

Fan can be mounted on walls, ceilings, I-beams and more, making it perfect for loading docks, restaurants, plants, health clubs and industrial areas where floor/table space is limited.

PRODUCT INFORMATION

Motor

3-speed, 1/6 HP, 120V, 1 phase, totally enclosed, ball bearing, permanently lubricated, permanent split capacitor (models 9318)

3-speed, 1/20 HP, 120V, 1 phase, totally enclosed, ball bearing, permanently lubricated, permanent split capacitor (model 9314)

3-speed, 1/25 HP, 120V, 1 phase, open motor, sleeve bearing, permanent split capacitor (model 9312)

Controls

Rear mounted pull cord switch

Power Cord

Black, 9', 3-conductor, SJT type (models 9318, 9314, 9312)

Coating

Blade, Guard, and Mounts are powder coated steel

Compliance

ETL, OSHA

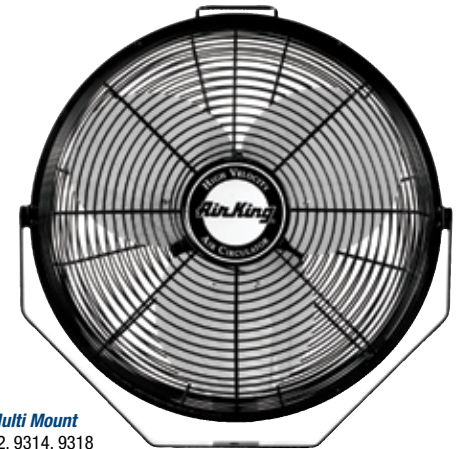

Multi Mount
9312, 9314, 9318

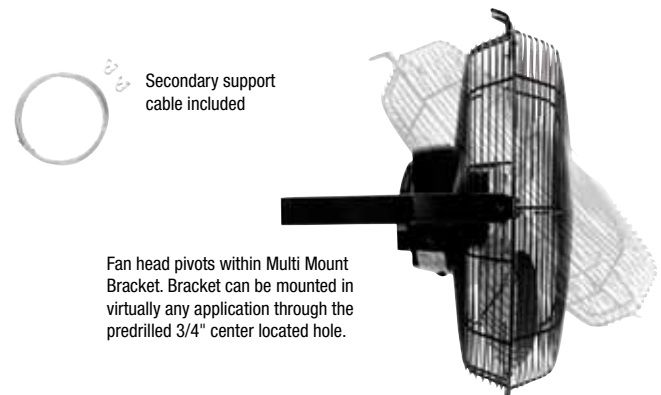

Secondary support
cable included

Fan head pivots within Multi Mount Bracket. Bracket can be mounted in virtually any application through the predrilled 3/4" center located hole.

SPECIFICATIONS

MODEL	DESCRIPTION	BLADE SIZE	PRODUCT DIMENSIONS	WEIGHT (LBS.)	CUBE (FEET)	LIST PRICE
9318	18" Multi Mount Fan	18"	21.5"L x 16"W x 21"H	21.4	2.85	\$165.00
9314	14" Multi Mount Fan	14"	18"L x 8.88"W x 18.25"H	14.3	1.85	\$139.00
9312	12" Multi Mount Fan	12"	15"L x 12"W x 15"H	11.5	1.39	\$125.00

PERFORMANCE

TYPE	CFM			RPM			AMPS			WATTS			DB A		
	HIGH	MED	LOW	HIGH	MED	LOW	HIGH	MED	LOW	HIGH	MED	LOW	HIGH	MED	LOW
9318	3190	2970	2660	1500	1300	1100	1.52	1.30	1.00	180	150	125	67	58	49
9314	1650	1470	1180	1498	1296	934	.58	.50	.44	63	56	48	58	55	48
9312	1360	1170	1010	1545	1205	900	.77	.63	.53	85	76	64	56	49	42

Tested in accordance with AMCA standard 230-99. • Specifications are subject to change.



INDUSTRIAL GRADE FLOOR FANS

Ideal for use in offices, stores, garages, warehouses and any other industrial space that needs powerful air circulation.

PRODUCT INFORMATION

Motor

3-speed, 1/4 HP, 120V, 1 phase, totally enclosed, ball bearing, permanently lubricated, permanent split capacitor (models 9224, 9230)

3-speed, 1/6 HP, 120V, 1 phase, totally enclosed, ball bearing, permanently lubricated, permanent split capacitor (models 9220, 9218, 9219)

3-speed, 1/20 HP, 120V, 1 phase, totally enclosed, ball bearing, permanently lubricated, permanent split capacitor (model 9214)

3-speed, 1/25 HP, 120V, 1 phase, open motor, sleeve bearing, permanent split capacitor (model 9212)

Controls

Rear mounted rotary switch

Power Cord

Black, 10', 3-conductor, SJT type (models 9224, 9230)

Black, 9', 3-conductor, SJT type (models 9220, 9218, 9219, 9214, 9212)

Coating

Blade, Guard, and Mounts are powder coated steel

Compliance

ETL, OSHA

Height

Adjustments of 26" and 28" (model 9219)

Roll-About Stand w/Fan
9219

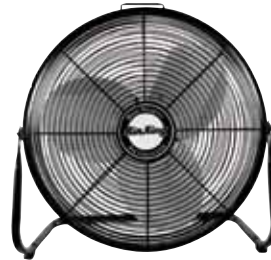
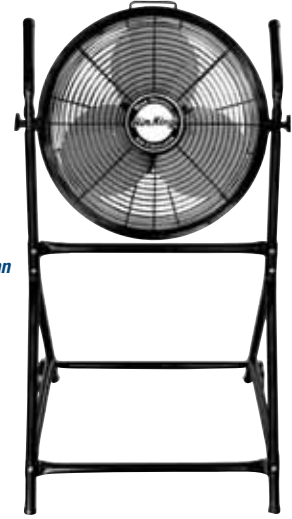

Pivoting Floor Fan
9220, 9218, 9214, 9212

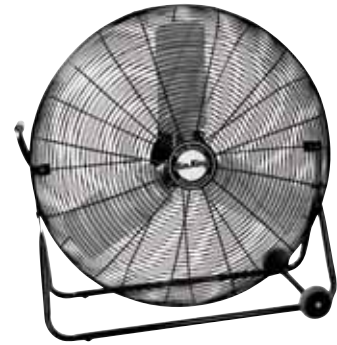

Pivoting Floor Fan
9230, 9224

SPECIFICATIONS

MODEL	DESCRIPTION	BLADE SIZE	PRODUCT DIMENSIONS	WEIGHT (LBS.)	CUBE (FEET)	LIST PRICE
9230	30" Pivoting Floor Fan	30"	33.75"L x 12.25"W x 35.5"H	48.3	8.63	\$330.00
9224	24" Pivoting Floor Fan	24"	27"L x 12"W x 28.75"H	41.8	5.69	\$310.00
9220	20" Pivoting Floor Fan	20"	25.75"L x 12.5"W x 25"H	24.0	4.46	\$170.00
9219	18" Roll-About Stand w/Fan	18"	24"L x 25"W x 48"H	27.9	4.44	\$215.00
9218	18" Pivoting Floor Fan		22"L x 9.69"W x 22"H	21.4	3.17	\$160.00
9214	14" Pivoting Floor Fan	14"	18.69"L x 9"W x 18"H	13.6	1.98	\$135.00
9212	12" Pivoting Floor Fan	12"	15.5"L x 8.5"W x 16.5"H	12.1	1.43	\$115.00

PERFORMANCE

MODEL	TYPE	CFM			RPM			AMPS			WATTS			DB A		
		HIGH	MED	LOW	HIGH	MED	LOW	HIGH	MED	LOW	HIGH	MED	LOW	HIGH	MED	LOW
9230	30" 1/4 HP	7400	6360	4980	1110	975	822	2.04	1.81	1.60	234	206	176	75	71	67
9224	24" 1/4 HP	5130	4490	3670	1500	1250	1000	2.03	1.81	1.63	229	200	176	72	69	64
9220	20" 1/6 HP	3670	3330	2940	1500	1310	1050	1.60	1.30	1.10	184	155	130	62	55	48
9219	18" 1/6 HP	3190	2970	2660	1500	1300	1100	1.52	1.30	1.00	180	150	125	67	58	49
9218	18" 1/6 HP	3190	2970	2660	1500	1300	1100	1.52	1.30	1.00	180	150	125	67	58	49
9214	12" 1/20 HP	1650	1470	1180	1498	1296	934	.58	.50	.44	63	56	48	58	55	48
9212	12" 1/25 HP	1360	1170	1010	1500	1200	900	.77	.63	.53	85	76	64	56	49	42

Tested in accordance with AMCA standard 230-99. • Specifications are subject to change.



GOVERNMENT FANS

Air King's government fans are perfect for use on military bases or in government buildings.

PRODUCT INFORMATION

Motor

3-speed, 1/4 HP, 120V, 60 Hz, 1 phase, totally enclosed, ball bearing, permanently lubricated, permanent split capacitor (models 9130G, 9135G, 9125G)

3-speed, 1/20 HP, 120V, 60 Hz, 1 phase, totally enclosed, ball bearing, permanently lubricated, permanent split capacitor (model 9214GT)

3-speed, 1/20 HP, 120V, 60 Hz, 1 phase, permanently lubricated, permanent split capacitor (model 3151G)

3-speed, 1/50 HP, 120V, 60 Hz, 1 phase, permanently lubricated (model 3150G)

Installation

Class A or B, NEMA Standard number MG-1

Power Cord

Black, 10', 3 wire, grounded, North American, SJT type, (models 9130G, 9135G, 9125G)

Black, 9', 3 wire, grounded, North American, SJT type (model 9214GT)

White, 7', 3 wire, grounded, North American, SPT type (models 3150G, 3151G)

Compliance

ETL Listed. Conforms to the requirements of Underwriters Laboratories Inc. (UL) Standard No. UL 507

Guards

Completely enclose the face, perimeter, and reverse side and permit access to blade assembly without special tools.

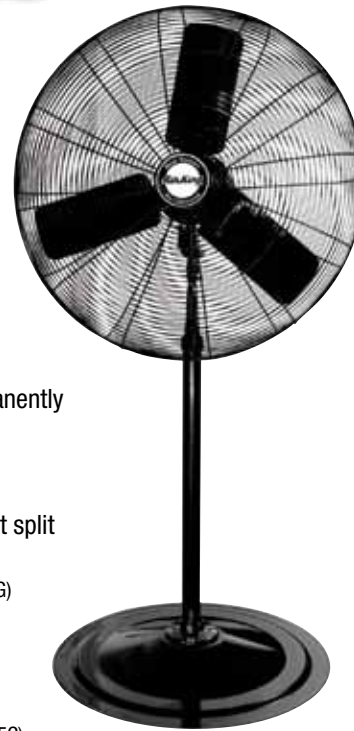

Pedestal Fans

9130G, 9135G, 9125G

Base is suitable for floor use and will not move when fan is operated at high speed

Floor Fan

9214GT

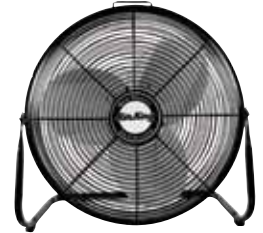

Table Fan

3150G, 3151G

Base is suitable for table, floor, or wall mounting and will not move when fan is operated at high speed

SPECIFICATIONS

MODEL	DESCRIPTION	BLADE SIZE	PRODUCT DIMENSIONS	WEIGHT (LBS.)	CUBE (FEET)	LIST PRICE
9130G	30" Pedestal Fan	30"	33.5"L x 29"W x 90"H	80.0	6.03	\$430.00
9135G	30" Oscillating Pedestal Fan		33.5"L x 29"W x 90"H	82.6	6.03	\$460.00
9125G	24" Oscillating Pedestal Fan	24"	27"L x 29"W x 88"H	76.1	8.26	\$440.00
9214GT	14" Floor Fan	14"	18.69"L x 9"W x 18"H	13.6	1.98	\$142.50
3150G	12" Oscillating Table/Wall Mount Fan	12"	11.63"L x 14.25"W x 20.25"H	8.0	1.46	\$75.00
3151G	16" Oscillating Table/Wall Mount Fan	16"	10.75"L x 18"W x 24.38"H	11.0	2.37	\$85.00

PERFORMANCE

MODEL	TYPE	CFM			RPM			AMPS			WATTS			DB A		
		HIGH	MED	LOW	HIGH	MED	LOW	HIGH	MED	LOW	HIGH	MED	LOW	HIGH	MED	LOW
9130G	30" 1/4 HP	7400	6360	4980	1110	975	822	2.04	1.81	1.60	234	206	176	75	71	67
9135G	30" 1/4 HP	7400	6360	4980	1110	975	822	2.04	1.81	1.60	234	206	176	75	71	67
9125G	24" 1/4 HP	5130	4490	3670	1500	1250	1000	2.03	1.81	1.63	229	200	176	72	69	64
9214GT	14" 1/20 HP	1650	1470	1180	1498	1296	934	.58	.50	.44	63	56	48	58	55	48
3150G	12" 1/50 HP	930	780	620	1450	1300	1090	.34	.30	.27	39	35	32	45	41	36
3151G	16" 1/20 HP	1392	1302	1142	1493	1360	1190	.81	.56	.48	85	67	57	57	49	44

Tested in accordance with AMCA standard 230-99. • Specifications are subject to change.



PIVOTING BLOWERS

PRODUCT INFORMATION

Motor

3-speed, 1/13 HP, 120V, 1 phase, totally enclosed, ball bearing, permanently lubricated, permanent split capacitor (model 9555)

3-speed, 1/16 HP, 120V, 1 phase, totally enclosed, ball bearing, permanently lubricated, permanent split capacitor (model 9550)

Controls

Side mounted rotary dial switch

Power Cord

Black, 10', 3-conductor with GFCI, SO type (model 9555)

Black, 10', 3-conductor, SO type (model 9550)

Construction

Molded ABS Plastic

Compliance

ETL, OSHA

Pivoting High Velocity Blower
9555

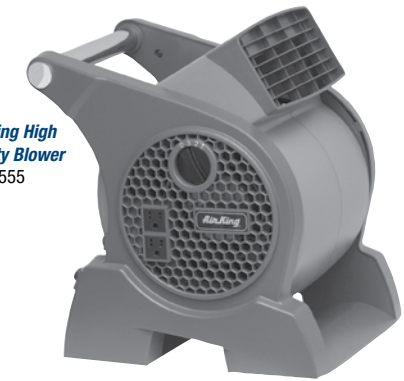

Pivoting Utility Blower
9550

BLADE SIZE	MOTOR SIZE	MODEL NUMBER	DESCRIPTION	CFM			AMPS			SHIP WEIGHT	LIST PRICE
				HIGH	MED	LOW	HIGH	MED	LOW		
7" x 7"	1/13 HP	9555	Pivoting High Velocity Blower	350	300	250	.94	.78	.70	12.8	\$180.00
6" x 6"	1/16 HP	9550	Pivoting Utility Blower	310	269	190	.80	.62	.50	10.1	\$120.00

Tested in accordance with AMCA standard 230-99. • Specifications are subject to change.

WINDOW FANS

PRODUCT INFORMATION

Motor

3-speed, 1/6 HP, 120V, 1 phase, totally enclosed, ball bearing, permanently lubricated, permanent split capacitor (model 9166)

3-speed, 1/6 HP, 120V, 1 phase, permanently lubricated, permanent split capacitor (model 9155)

Controls

Front mounted rotary switch

Power Cord

Black, 7', 3-conductor, SPT-2-R type (model 9166)

White, 7', 3-conductor, SPT-2-R type (model 9155)

Construction

Impact resistant plastic housing, powder coated steel front grill and blade (model 9166)

High impact styrene housing, ABS plastic blade, and metal front grill (model 9155)

Compliance

ETL, OSHA

Window Size Requirements

27" to 38" x 26.25"H (model 9166)

26.5" to 34.5" x 22"H (model 9155)



Whole House Window Fan
9166



Window Fan
9155

BLADE SIZE	MOTOR SIZE	MODEL NUMBER	DESCRIPTION	CFM			AMPS			SHIP WEIGHT	LIST PRICE
				HIGH	MED	LOW	HIGH	MED	LOW		
20"	1/6 HP	9166	20" Whole House Window Fan	3560	3120	2510	1.40	1.30	1.0	36.0	\$280.00
16"	1/6 HP	9155	16" Window Fan	2470	1700	1360	.83	.55	.45	15.0	\$180.00

Tested in accordance with AMCA standard 230-99. • Specifications are subject to change.



Model	Description	UPC	Page
Industrial Grade Drum Fans			
9942D	1/2 HP 42" Belt Drive Drum Fan	0-46013-30310-3	3
9936D	1/3 HP 36" Belt Drive Drum Fan	0-46013-30309-7	3
9236D	1/3 HP 36" Direct Drive Drum Fan	0-46013-30301-1	3
Industrial Grade Quiet Fans			
99532	30" Quiet, Oscillating Pedestal Fan	0-46013-39565-8	4
99533	24" Quiet, Oscillating Pedestal Fan	0-46013-39515-3	4
99538	30" Quiet, Oscillating Wall Mount Fan	0-46013-39555-9	5
99539	24" Quiet, Oscillating Wall Mount Fan	0-46013-39495-8	5
1/3 HP Industrial Grade Fan Components			
9170H	30" Assembled Fan Head	0-46013-38740-0	6
9175H	30" Oscillating Assembled Fan Head	0-46013-38730-1	6
9171H	24" Assembled Fan Head	0-46013-38720-2	6
9174H	24" Oscillating Assembled Fan Head	0-46013-38710-3	6
9100PB	Pedestal Base and Pole	0-46013-39620-4	6
9100WC	Wall Mount	0-46013-39630-3	6
9100CM	Ceiling Mount	0-46013-38700-4	6
9100i	I-Beam Mount	0-46013-39640-2	6
9100WB	Wheel Kit	0-46013-39590-0	6
1/3 HP Industrial Grade Fans			
9170	30" Pedestal Fan	0-46013-38990-9	7
9175	30" Oscillating Pedestal Fan	0-46013-38960-2	7
9171	24" Pedestal Fan	0-46013-38980-0	7
9174	24" Oscillating Pedestal Fan	0-46013-38970-1	7
9070	30" Wall Mount Fan	0-46013-38940-4	7
9075	30" Oscillating Wall Mount Fan	0-46013-38920-6	7
9071	24" Wall Mount Fan	0-46013-38950-3	7
9074	24" Oscillating Wall Mount Fan	0-46013-38930-5	7
9370	30" Ceiling Mount Fan	0-46013-38900-8	7
9375	30" Oscillating Ceiling Mount Fan	0-46013-38880-3	7
9371	24" Ceiling Mount Fan	0-46013-38910-7	7
9374	24" Oscillating Ceiling Mount Fan	0-46013-38890-2	7
9670	30" I-Beam Mount Fan	0-46013-38860-5	7
9675	30" Oscillating I-Beam Mount Fan	0-46013-38840-7	7
9671	24" I-Beam Mount Fan	0-46013-38870-4	7
9674	24" Oscillating I-Beam Mount Fan	0-46013-38850-6	7
1/4 HP Industrial Grade Fan Components			
9130H	30" Assembled Fan Head	0-46013-39600-6	8
9135H	30" Oscillating Assembled Fan Head	0-46013-39730-0	8
9124H	24" Assembled Fan Head	0-46013-39610-5	8
9125H	24" Oscillating Assembled Fan Head	0-46013-39740-9	8
9120H	20" Assembled Fan Head	0-46013-38750-9	8
9121H	20" Oscillating Assembled Fan Head	0-46013-38690-8	8
9100PB	Pedestal Base and Pole	0-46013-39620-4	8
9100WC	Wall Mount	0-46013-39630-3	8
9100CM	Ceiling Mount	0-46013-38700-4	8
9100i	I-Beam Mount	0-46013-39640-2	8
9100WB	Wheel Kit	0-46013-39590-0	8

Specifications are subject to change.

Model	Description	UPC	Page
1/4 HP Industrial Grade Fans			
9130	30" Pedestal Fan	0-46013-11780-9	9
9135	30" Oscillating Pedestal Fan	0-46013-39560-3	9
9124	24" Pedestal Fan	0-46013-39500-9	9
9125	24" Oscillating Pedestal Fan	0-46013-39510-8	9
9030	30" Wall Mount Fan	0-46013-39350-0	9
9035	30" Oscillating Wall Mount Fan	0-46013-39550-4	9
9024	24" Wall Mount Fan	0-46013-39480-4	9
9025	24" Oscillating Wall Mount Fan	0-46013-39490-3	9
9330	30" Ceiling Mount Fan	0-46013-38800-1	9
9335	30" Oscillating Ceiling Mount Fan	0-46013-38780-6	9
9724	24" Ceiling Mount Fan	0-46013-38810-0	9
9325	24" Oscillating Ceiling Mount Fan	0-46013-38790-5	9
9430	30" I-Beam Mount Fan	0-46013-39670-9	9
9635	30" Oscillating I-Beam Mount Fan	0-46013-38760-8	9
9424	24" I-Beam Mount Fan	0-46013-39690-7	9
9625	24" Oscillating I-Beam Mount Fan	0-46013-38770-7	9
20" and 18" Industrial Grade Fans			
9420	1/6 HP 20" Pedestal Fan	0-46013-39290-9	10
9020	1/6 HP 20" Wall Mount Fan	0-46013-39340-1	10
9320	1/6 HP 20" Ceiling Mount Fan	0-46013-38820-9	10
9520	1/6 HP 20" I-Beam Mount Fan	0-46013-39650-1	10
9418	1/6 HP 18" Pedestal Fan	0-46013-39680-8	10
9518	1/6 HP 18" Wall Mount Fan	0-46013-39660-0	10
9718	1/6 HP 18" Ceiling Mount Fan	0-46013-38830-8	10
9618	1/6 HP 18" I-Beam Mount Fan	0-46013-39700-3	10
Industrial Grade Multi Mount Fans			
9318	1/6 HP 18" Multi Mount Fan	0-46013-39470-5	11
9314	1/20 HP 14" Multi Mount Fan	0-46013-39720-1	11
9312	1/25 HP 12" Multi Mount Fan	0-46013-39460-6	11
Industrial Grade Floor Fans			
9230	1/4 HP 30" Floor Fan	0-46013-39570-2	12
9224	1/4 HP 24" Floor Fan	0-46013-39520-7	12
9220	1/6 HP 20" Floor Fan	0-46013-39300-5	12
9219	1/6 HP 18" Roll-About Stand Fan	0-46013-39190-2	12
9218	1/6 HP 18" Floor Fan	0-46013-39170-4	12
9214	1/20 HP 18" Floor Fan	0-46013-39710-2	12
9212	1/25 HP 12" Floor Fan	0-46013-39160-5	12
Government Fans			
9130G	30" Pedestal Fan	0-46013-11750-2	13
9135G	30" Oscillating Pedestal Fan	0-46013-38200-9	13
9125G	24" Oscillating Pedestal Fan	0-46013-38190-3	13
9214GT	14" Floor Fan	0-46013-39710-2	13
3150G	12" Oscillating Table/Wall Mount Fan	0-46013-32200-5	13
3151G	16" Oscillating Table/Wall Mount Fan	0-46013-32210-4	13
Pivoting Blowers			
9555	Pivoting High Velocity Blower	0-46013-43620-7	14
9550	Pivoting Utility Blower	0-46013-39840-6	14
Window Fans			
9166	20" Whole House Window Fan	0-46013-38020-3	14
9155	16" Window Fan	0-46013-38010-4	14



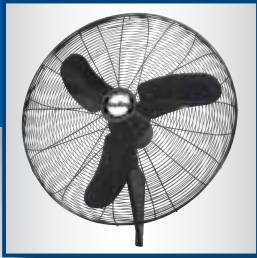

For additional information regarding our industrial air circulators or any of our other full lines of commercial grade fans, exhaust fans, range hoods, ceiling fans, door entry chimes, or humidifiers please contact the dealer nearest you or:

United States:

West Chester, PA
Phone: 877-304-3785 • Fax: 610-696-8048
E-mail: sales@airkinglimited.com

Canada:

Brampton, Ontario
Phone: 800-250-8767 • Fax: 905-456-1015
E-mail: casales@airkinglimited.com

